

ECT AND A/T INDICATOR

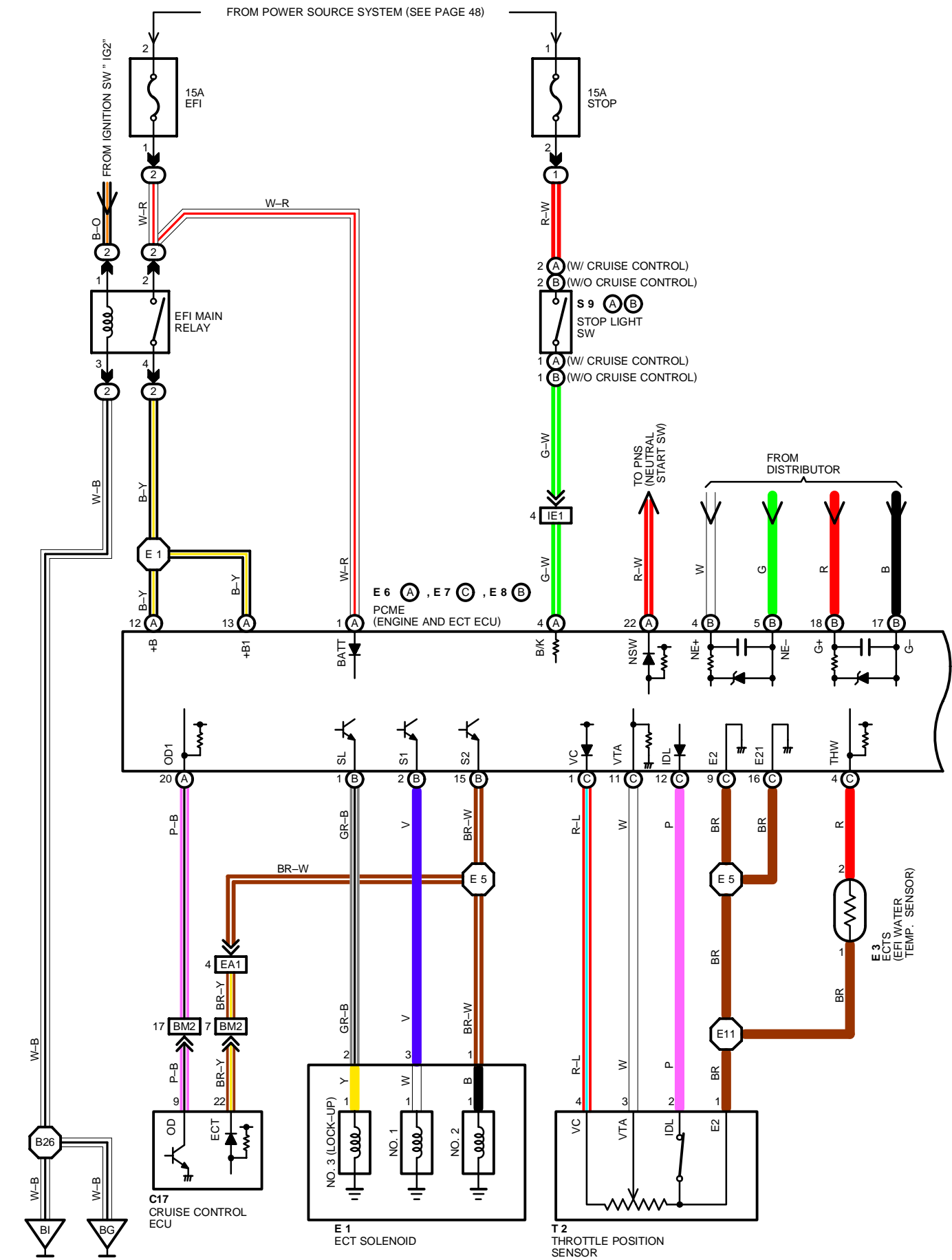

FROM POWER SOURCE SYSTEM (SEE PAGE 48)

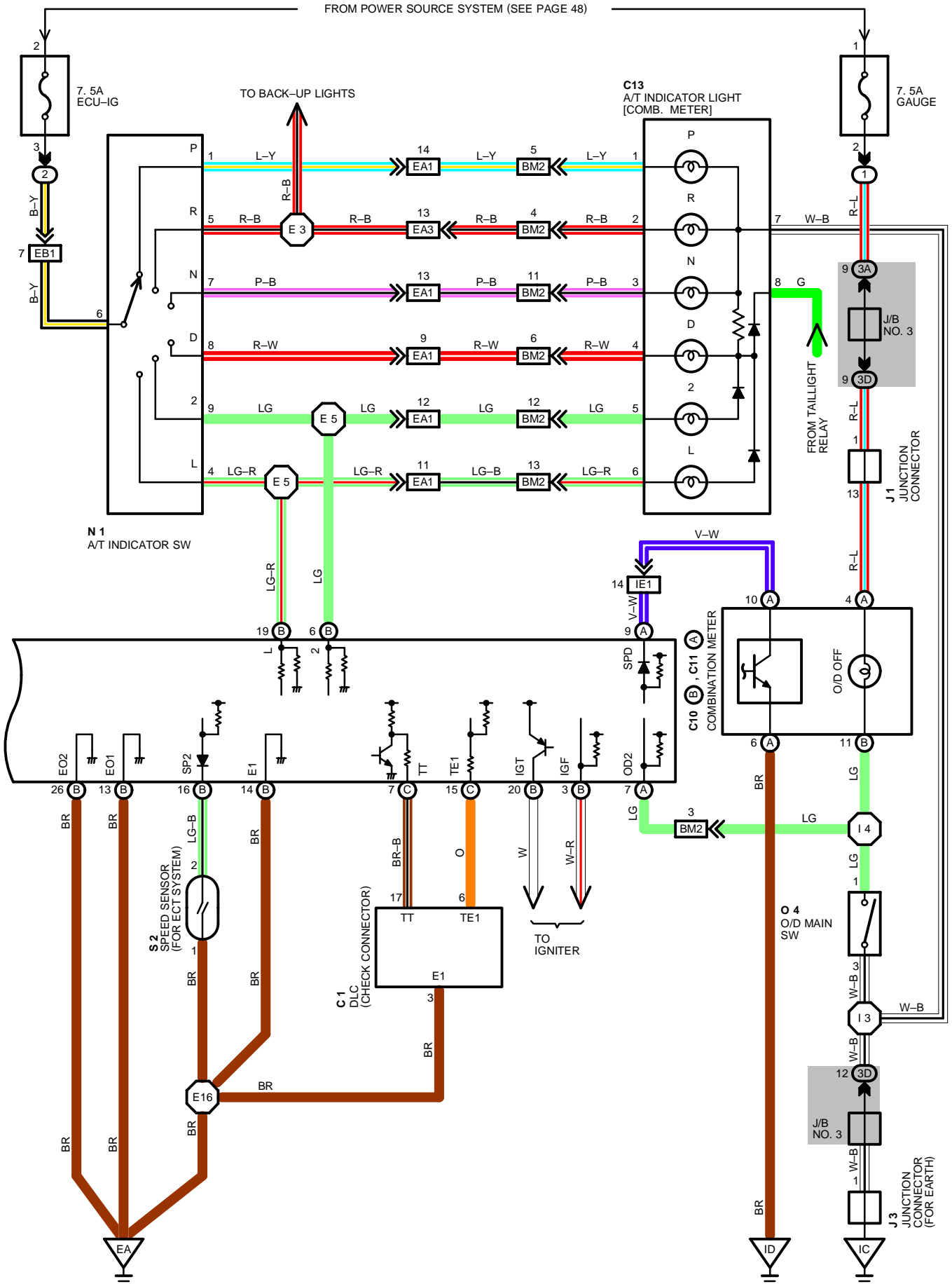

ECT AND A/T INDICATOR

SYSTEM OUTLINE

THIS SYSTEM ELECTRONICALLY CONTROLS THE GEAR SHIFT TIMING, LOCK-UP TIMING, THE CLUTCH AND BRAKE HYDRAULIC PRESSURE, AND THE ENGINE TORQUE DURING SHIFTING, TO ACHIEVE OPTIMUM SHIFT FEELING.

IN ACCORDANCE TO THE VEHICLE DRIVING CONDITIONS AND ENGINE OPERATING CONDITIONS AS DETECTED BY VARIOUS SENSORS.

1. GEAR SHIFT OPERATION

DURING DRIVING, THE PCME (ENGINE AND ECT ECU) SELECTS THE SHIFT FOR EACH GEAR WHICH IS MOST APPROPRIATE TO THE DRIVING CONDITIONS, BASED ON INPUT SIGNALS FROM THE ECTS (EFI WATER TEMP. SENSOR) TO **TERMINAL THW** OF THE PCME (ENGINE AND ECT ECU), AND ALSO THE INPUT SIGNALS TO **TERMINAL SP2** OF THE PCME (ENGINE AND ECT ECU) FROM THE SPEED SENSOR DEVOTED TO THE ECT. CURRENT IS THEN OUTPUT TO THE ECT SOLENOIDS. WHEN SHIFTING TO 1ST SPEED, CURRENT FLOWS FROM **TERMINAL S1** OF THE PCME (ENGINE AND ECT ECU) → **TERMINAL 3** OF THE ECT SOLENOIDS → **GROUND**, AND CONTINUITY FLOW TO NO.1 SOLENOID CAUSES THE SHIFT.

FOR 2ND SPEED, CURRENT FLOWS FROM **TERMINAL S1** OF THE PCME (ENGINE AND ECT ECU) → **TERMINAL 3** OF THE ECT SOLENOIDS → **GROUND**, AND FROM **TERMINAL S2** OF THE PCME (ENGINE AND ECT ECU) → **TERMINAL 1** OF THE ECT SOLENOIDS → **GROUND**, AND CONTINUITY TO SOLENOIDS NO. 1 AND NO. 2 CAUSE THE SHIFT.

FOR 3RD SPEED, THERE IS NO CONTINUITY TO NO. 1 SOLENOID, ONLY TO NO. 2, CAUSING THE SHIFT.

SHIFTING INTO 4TH SPEED (OVER DRIVE) TAKES PLACE WHEN THERE IS NO CONTINUITY TO EITHER NO. 1 OR NO. 2 SOLENOID.

2. LOCK-UP OPERATION

WHEN THE PCME (ENGINE AND ECT ECU) JUDGES FROM EACH SIGNAL THAT LOCK-UP OPERATION CONDITIONS HAVE BEEN MET, CURRENT FLOWS FROM **TERMINAL SL** OF THE PCME (ENGINE AND ECT ECU) → **TERMINAL 2** OF THE ETC SOLENOIDS → **GROUND**, CAUSING A CONTINUITY TO THE TCC (LOCK-UP SOLENOID) AND CAUSING LOCK-UP OPERATION.

3. STOP LIGHT SW CIRCUIT

IF THE BRAKE PEDAL IS DEPRESSED (STOP LIGHT SW ON) WHEN DRIVING IN LOCK-UP CONDITION, A SIGNAL IS INPUT TO **TERMINAL B/K** OF THE PCME (ENGINE AND ECT ECU), THE PCME (ENGINE AND ECT ECU) OPERATES AND CONTINUITY TO THE TCC (LOCK-UP SOLENOID) IS CUT.

4. OVERDRIVE CIRCUIT

* O/D MAIN SW ON

WHEN THE O/D MAIN SW IS TURNED ON (O/D OFF INDICATOR LIGHT TURNS OFF), A SIGNAL IS INPUT TO **TERMINAL OD2** OF THE PCME (ENGINE AND ECT ECU) AND PCME (ENGINE AND ECT ECU) OPERATION CAUSES GEAR SHIFT WHEN THE CONDITIONS FOR OVERDRIVE ARE MET.

* O/D MAIN SW OFF

WHEN THE OVERDRIVE SW IS TURNED OFF, THE CURRENT FLOWING THROUGH THE O/D OFF INDICATOR LIGHT FLOWS THROUGH THE O/D MAIN SW TO **GROUND**, CAUSING THE INDICATOR LIGHT TO LIGHT UP. AT THE SAME TIME, A SIGNAL IS INPUT TO **TERMINAL OD2** OF THE PCME (ENGINE AND ECT ECU) AND PCME (ENGINE AND ECT ECU) OPERATION PREVENTS SHIFT INTO OVERDRIVE.

SERVICE HINTS

E 6(A), E 7(C), E 8(B) PCME (ENGINE AND ECT ECU)

- (A) 4- (B)14 : 10-14 VOLTS (BRAKE PEDAL IS DEPRESSED)
1 VOLTS OR LESS (BRAKE PEDAL IS RELEASED)
- (C) 4- (C) 9 : 0.3-0.8 VOLTS (IGNITION SW ON AND COOLANT TEMP. 80°C (176°F))
- (C)12- (C) 9 : 8-14 VOLTS (IGNITION SW ON AND THROTTLE VALVE FULLY OPEN)
- (C)11- (C) 9 : 0.8-1.2 VOLTS (IGNITION SW ON AND THROTTLE VALVE FULLY CLOSED)
3.2-4.2 VOLTS (IGNITION SW ON AND THROTTLE VALVE FULLY OPEN)
- (C) 1- (C) 9 : 4.5-5.5 VOLTS (IGNITION SW ON)
- (A)20- (B)14 : 10-14 VOLTS (IGNITION SW ON)
- (A) 7- (B)14 : 10-14 VOLTS (IGNITION SW ON AND O/D MAIN SW TURNED ON)
1 VOLTS OR LESS (IGNITION SW ON AND O/D MAIN SW TURNED OFF)
- (A) 9- (B)14 : 1 VOLTS OR LESS (IGNITION SW ON, CRUISE CONTROL SW OFF AND STARTING STILL)
0 ↔ 10-14 VOLTS REPEAT (IGNITION SW ON, CRUISE CONTROL SW OFF AND VEHICLE MOVING)
- (B)16- (B)14 : 1 VOLTS OR LESS (IGNITION SW ON AND STARTING STILL)
0 ↔ 4.5-5.5 VOLTS REPEAT (IGNITION SW ON AND VEHICLE MOVING)
- (A)22- (B)14 : 6.0-14 VOLTS (IGNITION SW ON AND PNS (NEUTRAL START SW) P OR N POSITION)
0-2.0 VOLTS (IGNITION SW ON AND EX. PNS (NEUTRAL START SW) P OR N POSITION)
- (B) 6- (B)14 : 10-14 VOLTS (IGNITION SW ON AND PNS (NEUTRAL START SW) 2 POSITION)
1 VOLTS OR LESS (IGNITION SW ON AND EX. PNS (NEUTRAL START SW) 2 POSITION)
- (B)19- (B)14 : 10-14 VOLTS (IGNITION SW ON AND PNS (NEUTRAL START SW) L POSITION)
1 VOLTS OR LESS (IGNITION SW ON AND EX. PNS (NEUTRAL START SW) L POSITION)
- (A)12- (A)13- (B)14 : 10-14 VOLTS (IGNITION SW ON)
- (A) 1- (B)14 : 10-14 VOLTS (ALL CONDITIONS)

 : PARTS LOCATION

CODE	SEE PAGE	CODE	SEE PAGE	CODE	SEE PAGE
C 1	24 (5S-FE)	E 3	24 (5S-FE)	N 1	24 (5S-FE)
C10	B 26	E 6	A 24 (5S-FE)	O 4	26 (5S-FE)
C11	A 26	E 7	C 24 (5S-FE)	S 2	24 (5S-FE)
C13	26 (5S-FE)	E 8	B 24 (5S-FE)	S 9	A 26
C17	26	J 1	26		B 26
E 1	24 (5S-FE)	J 3	26	T 2	24 (5S-FE)

 : RELAY BLOCKS

CODE	SEE PAGE	RELAY BLOCKS (RELAY BLOCK LOCATION)
1	20	R/B NO. 1 (LEFT KICK PANEL)
2	21	R/B NO. 2 (ENGINE COMPARTMENT LEFT)

 : JUNCTION BLOCK AND WIRE HARNESS CONNECTOR

CODE	SEE PAGE	JUNCTION BLOCK AND WIRE HARNESS (CONNECTOR LOCATION)
3A	22	COWL WIRE AND J/B NO. 3 (BEHIND COMBINATION METER)
3D		

 : CONNECTOR JOINING WIRE HARNESS AND WIRE HARNESS

CODE	SEE PAGE	JOINING WIRE HARNESS AND WIRE HARNESS (CONNECTOR LOCATION)
EA1	28 (5S-FE)	ENGINE ROOM MAIN WIRE AND ENGINE WIRE (REAR LUGGAGE COMPARTMENT LEFT)
EA3	28 (5S-FE)	ENGINE WIRE AND ENGINE ROOM MAIN WIRE (R/B NO. 2 INNER)
EB1	28 (5S-FE)	ENGINE WIRE AND R/B NO. 2 (R/B NO. 2 INNER)
IE1	32	ENGINE ROOM MAIN WIRE AND COWL WIRE (LEFT KICK PANEL)
BM2	36	COWL WIRE AND ENGINE ROOM MAIN WIRE (ROOM PARTITION BOARD LEFT)

 : GROUND POINTS

CODE	SEE PAGE	GROUND POINTS LOCATION
EA	28 (5S-FE)	INTAKE MANIFOLD
IC	32	INSTRUMENT PANEL BRACE LH
ID	32	RIGHT KICK PANEL
BG	36	UNDER THE LEFT CENTER PILLAR
BI	36	BACK PANEL CENTER

 : SPLICE POINTS

CODE	SEE PAGE	WIRE HARNESS WITH SPLICE POINTS	CODE	SEE PAGE	WIRE HARNESS WITH SPLICE POINTS
E 1	28 (5S-FE)	ENGINE ROOM MAIN WIRE	E16	28 (5S-FE)	ENGINE WIRE
E 3			I 3	34	COWL WIRE
E 5			I 4		
E11	28 (5S-FE)	ENGINE WIRE	B26	36	ENGINE ROOM MAIN WIRE

ECT AND A/T INDICATOR

C 1 DARK GRAY

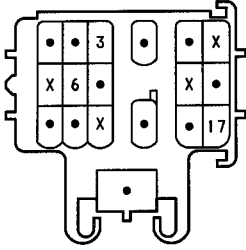

C10 Ⓑ BROWN

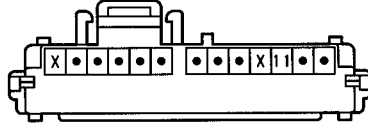

C11 Ⓐ BLUE

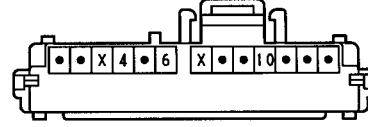

C13



C17 GRAY

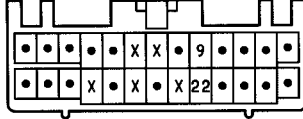

E 1 BLACK



E 3 GREEN



E 6 Ⓐ DARK GRAY

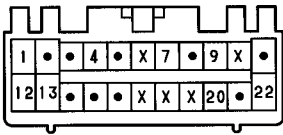

E 7 Ⓒ DARK GRAY

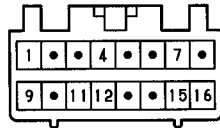

E 8 Ⓑ DARK GRAY

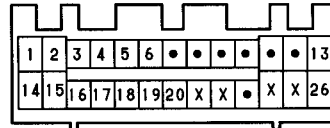

J 1

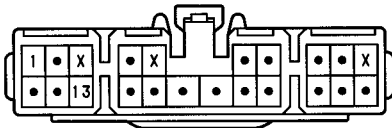

J 3

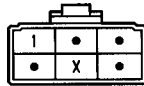

N 1 GRAY

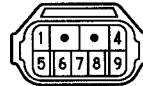

O 4



S 2 GRAY



S 9 Ⓐ BLUE

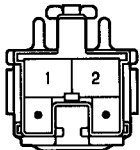

S 9 Ⓑ

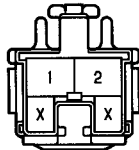

T 2 BLACK

