

TROUBLESHOOTING WITH VOLT OHMMETER

HINT:

EG0XT-01

- The following troubleshooting procedures are designed for inspection of each separate system, and therefore the actual procedure may vary somewhat. However, troubleshooting should be performed while referring to the inspection methods described in this manual.
- Before beginning inspection, it is best to first make a simple check of the fuses, H-fuses, fusible link and the condition of the connectors.
- The following troubleshooting procedures are based on the supposition that the trouble lies in either a short or open circuit within the computer.
- If engine trouble occurs even though proper operating voltage is detected in the computer connector, then it can be assumed that the PCME is faulty and should be replaced.

FUSES, H-FUSES AND FUSIBLE LINK LOCATION

EG0XU-01

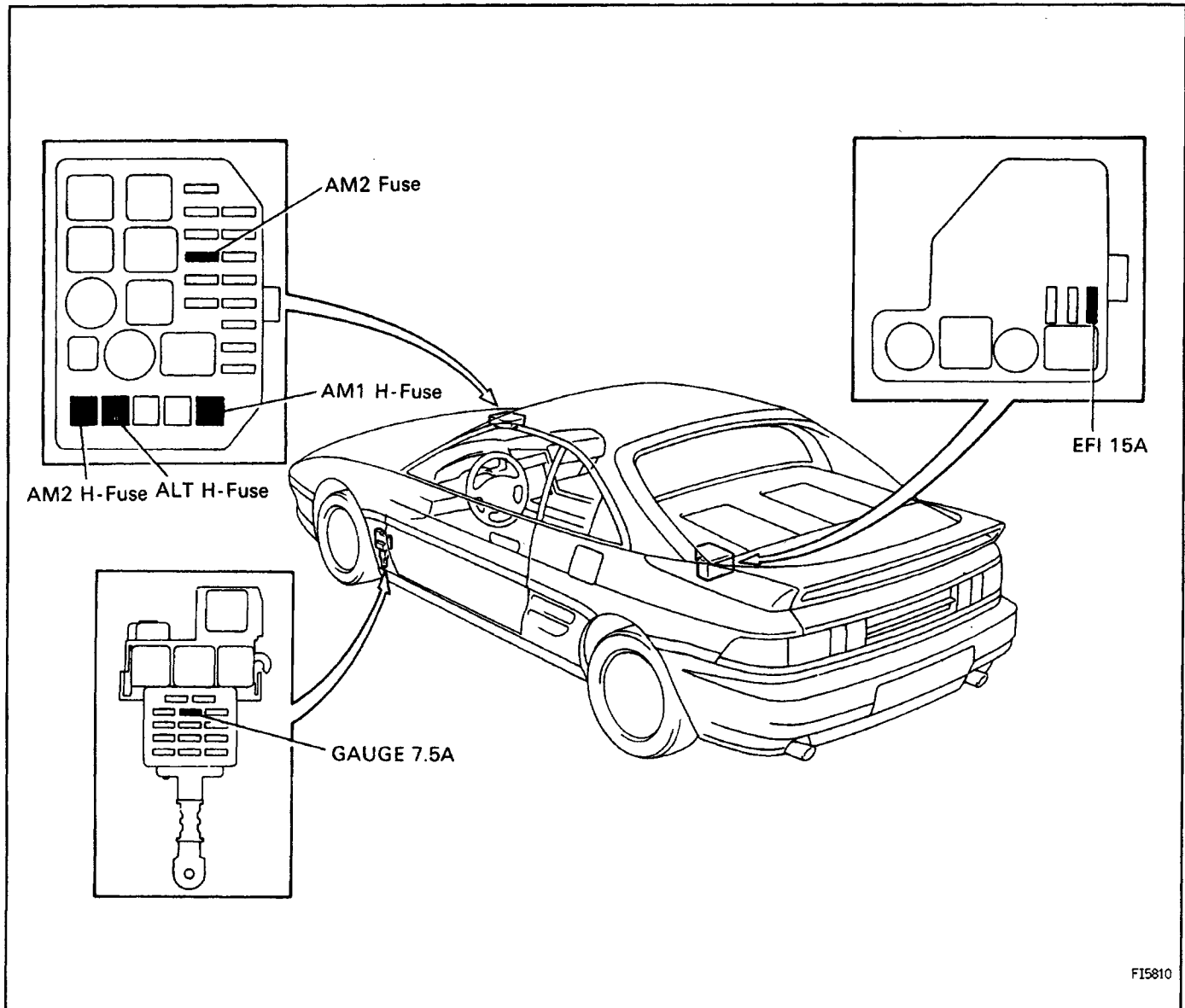

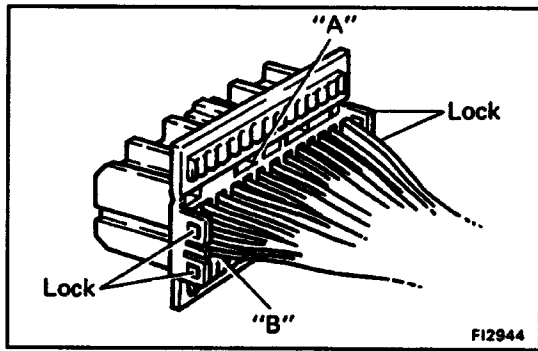

SMPI SYSTEM CHECK PROCEDURE

890KV-01

PREPARATION

- (a) Disconnect the connectors from the PCME.
- (b) Remove the locks as shown in the illustration so that the tester probe(s) can easily come in.

NOTICE: Pay attention to sections 'A' and 'B' in the Illustration which can be easily broken.

- (c) Reconnect the connectors to the PCME.

HINT:

- Perform all voltage measurements with the connectors connected.
- Verify that the battery voltage is 11 V or more when the ignition switch is in the "ON" position.

Using a voltmeter with high impedance (10 k Ω /V minimum), measure the voltage at each terminal of the wiring connectors.

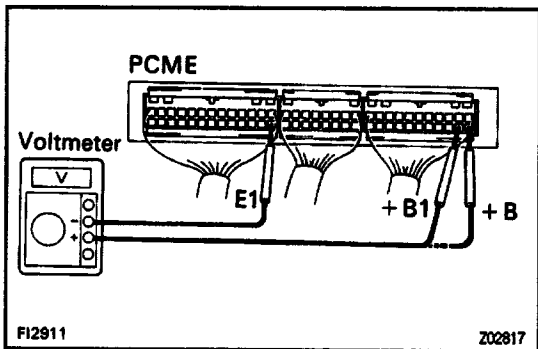

PCME Wiring Connectors Voltage

No.	Terminals	Condition	STD voltage (V)	See page	
1	+ B + B1 - E1	IGS WON	9-14	EG1-296	
2	BATT - E1	-	9-14	EG1-297	
3	IDL - E2	IG SW ON	Throttle valve open	9-14	EG1-298
	VC - E2		-	4.5-5.5	
	VTA - E2		Throttle valve fully closed (Throttle opener must be cancelled first)	0.3-0.8	
4	VC - E2	IG SW ON	Throttle valve fully open	3.2-4.9	EG1-300
			-	4.5-5.5	
	VS - E2		Measuring plate fully closed	4.0-5.5	
			Measuring plate fully open	0.2-0.5	
			Idling	1.6-4.1	
3,000 rpm	1.0-2.0				
5	#1 #2 E01 #3 E02 #4	IG SW ON	9-14	EG1-301	
6	THA - E2	IG SW ON	Intake air temp. 20°C (68°F)	0.5-3.4	EG1-302
7	THW - E2		Coolant temp. 80°C (176°F)	0.2-1.0	EG1-303
8	STA - E1	Cranking	6 or more	EG1-304	
9	IGT - E1	Idling	Pulse generation	EG1-305	
10	RSC RSO - E1	IG SW ON	PCME connectors disconnected	9-14	EG1-306
11	W - E1	No trouble ("CHECK" engine warning light off) and engine running		9-14	EG1-307
12	PIM - E2	IG SW ON		2.5-4.5	EG1-308
	VC - E2			4.5-5.5	
13	AC - E1	IG SW ON	Air conditioning ON	9-14	EG1-309

PCM E Terminals

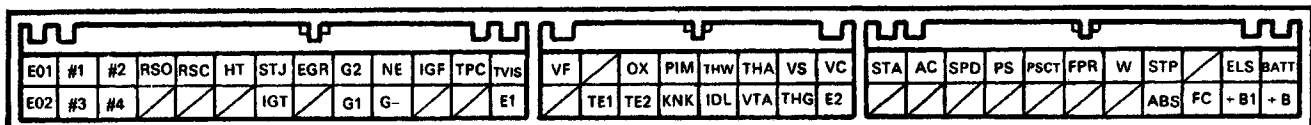

F12796

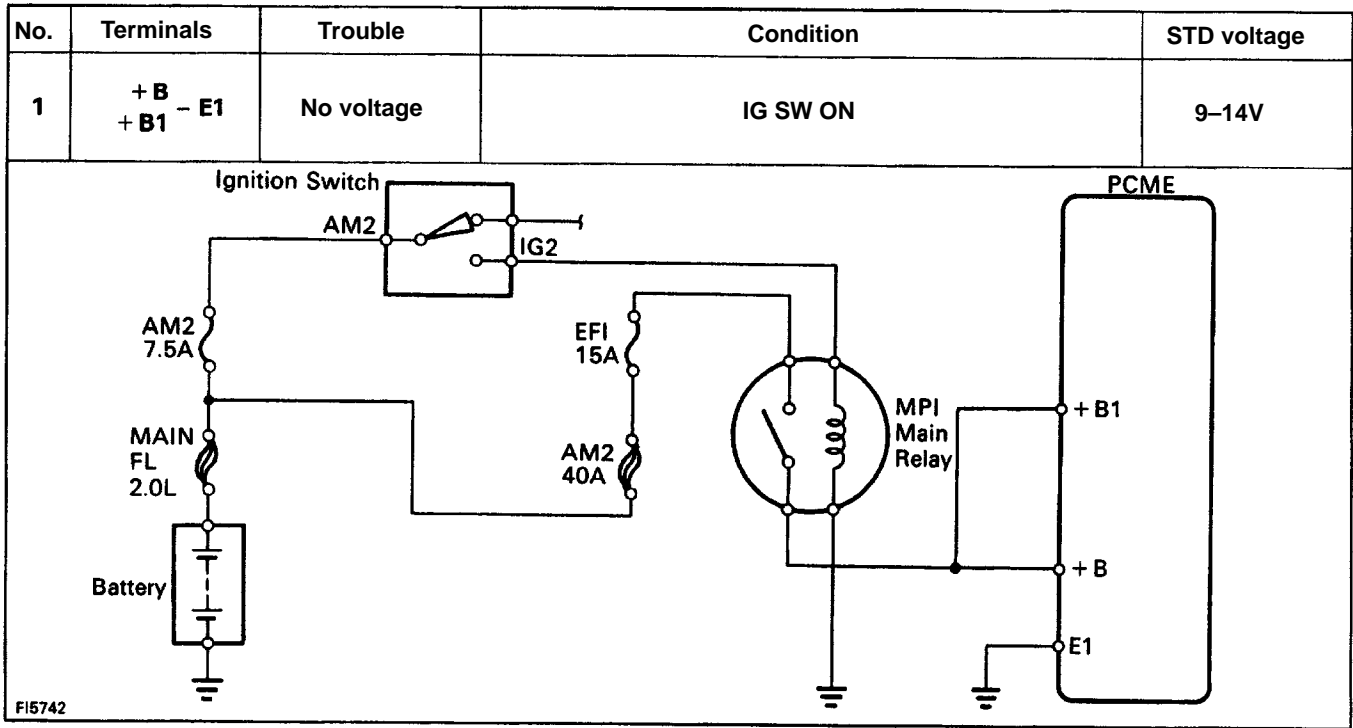

FI5742

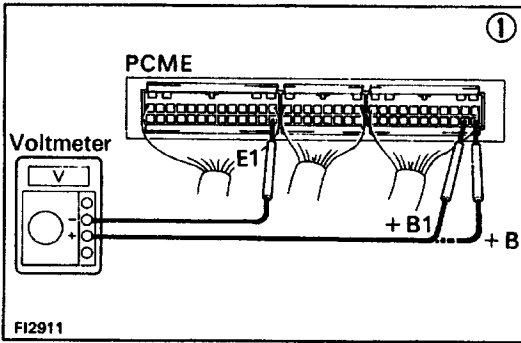

FI2911

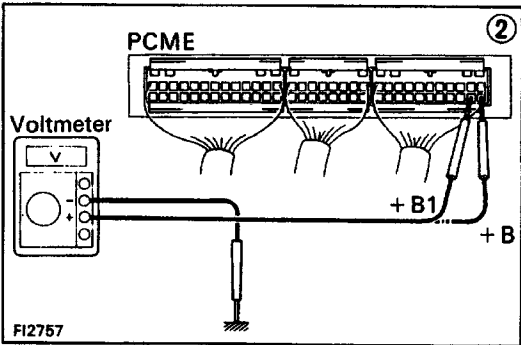

FI2757

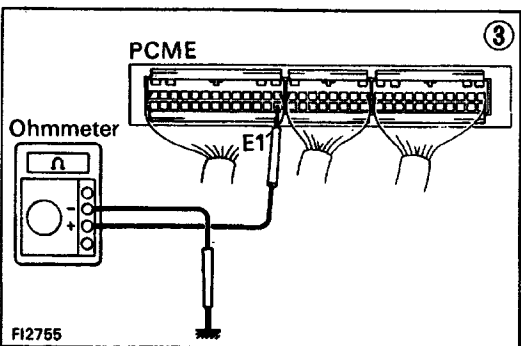

FI2755

1 There is no voltage between PCME terminals + B or + B1 and E1. (IG SW ON)

2 Check that there is voltage between PCME terminal + B or + B1 and body ground. (IG SW ON)

NO OK

3 Check wiring between PCME terminal E1 and body ground.

OK

BAD

Try another PCM E.

Repair or replace.

Check fuses, N-fuse, fusible link and ignition switch.

BAD

Repair or replace.

OK

Check M PI main relay. (See page EG1-374)

BAD

Replace.

OK

Check wiring between MPI main relay and battery.

BAD

Repair or replace.

No.	Terminals	Trouble	Condition	STD voltage
2	BATT - E1	No voltage	-	9-14V

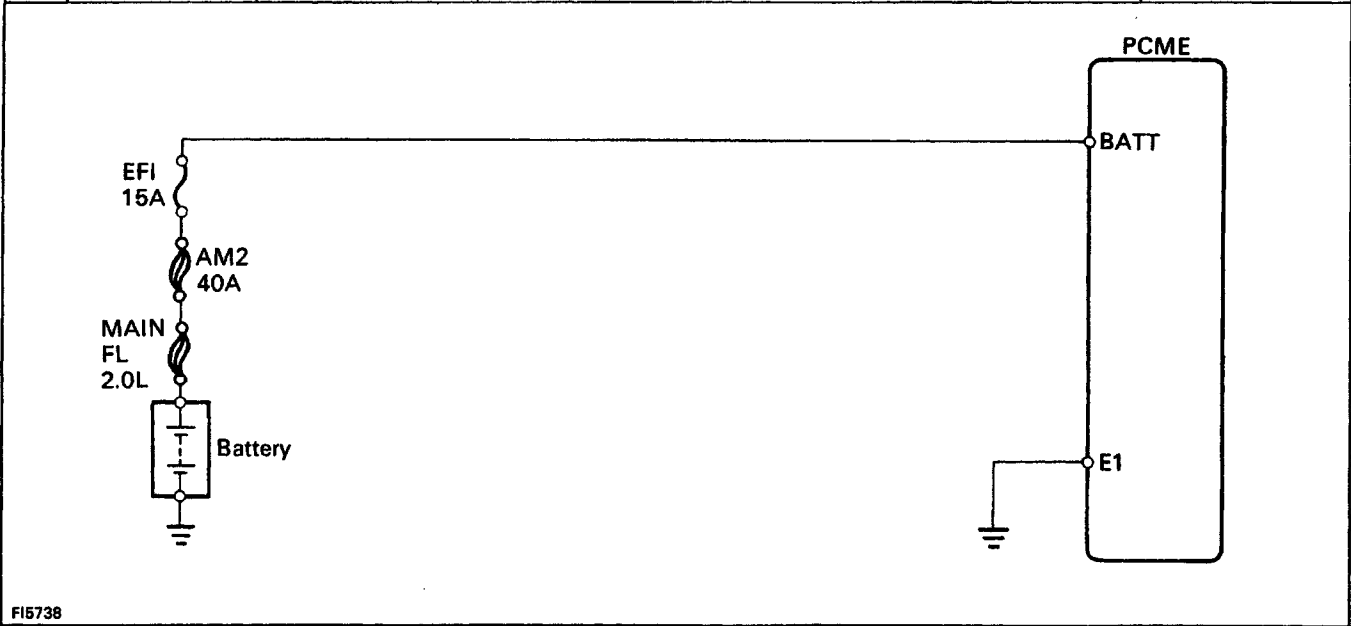

FI5738

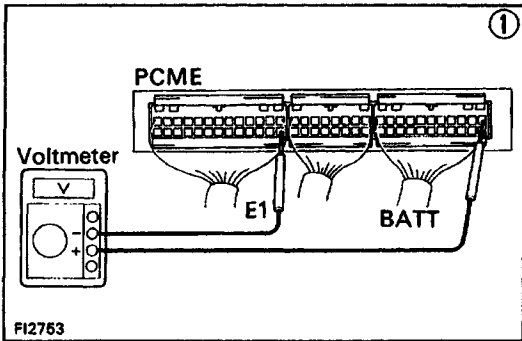

FI2763

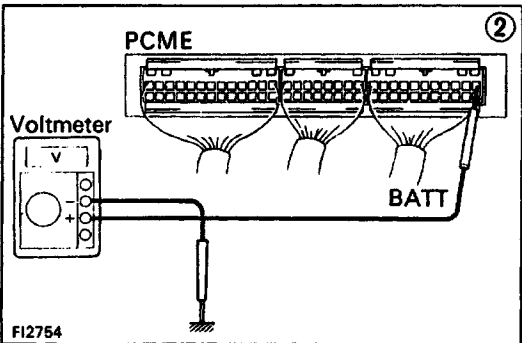

FI2754

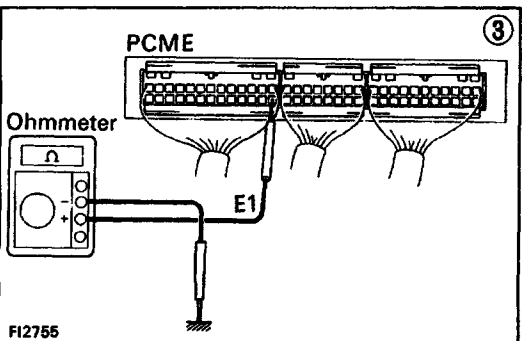

FI2755

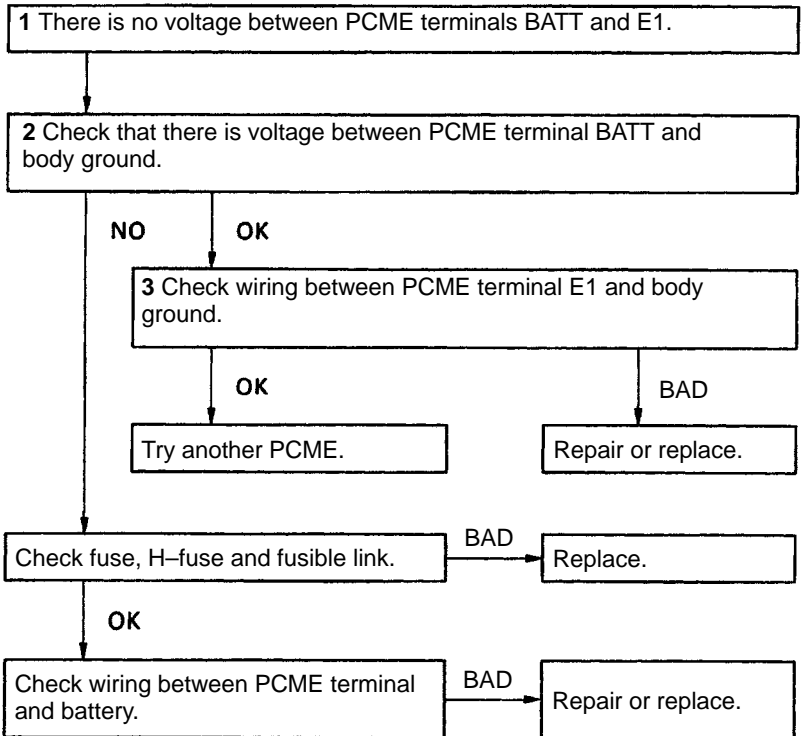

No.	Terminals	Trouble	Condition	STD voltage	
3	IDL - E2	No voltage	IG SW ON	Throttle valve open	9 - 14 V
	VC - E2			4.5 - 5.5 V	
	VTA - E2			Throttle valve fully closed Throttle opener must be cancelled first	0.3 - 0.8 V
				Throttle valve fully open	3.2 - 4.9 V

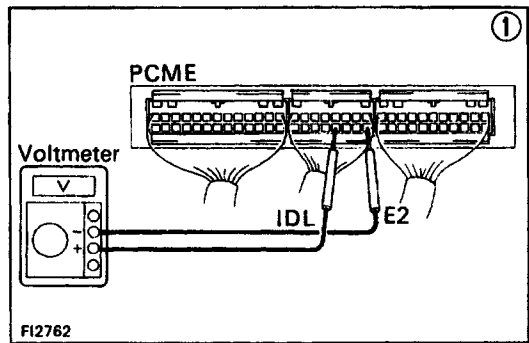
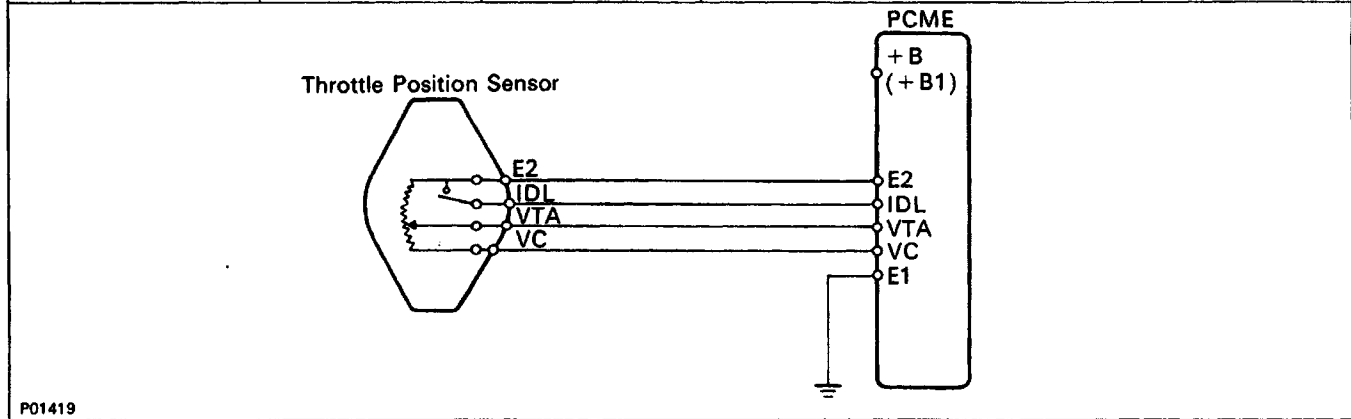

• IDL - E2

① There is no voltage between PCME terminals IDL and E2. (IG SW ON) (Throttle valve open)

② Check that there is voltage between PCME terminal + B (+ B1) and body ground. (IG SW ON)

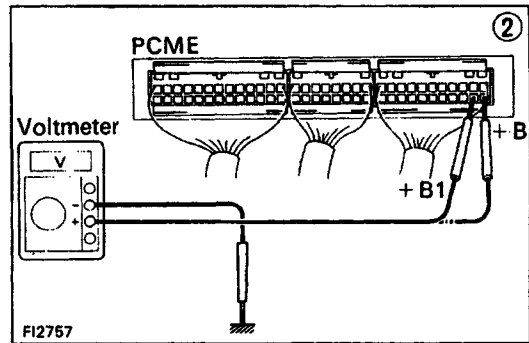
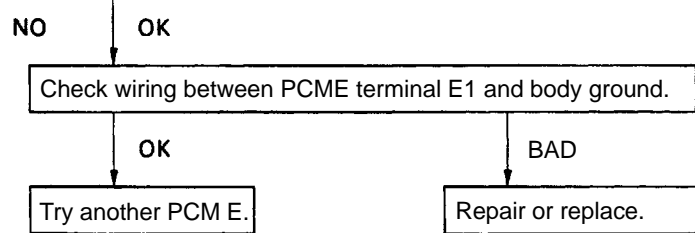

Refer to No. 1. (See page EG1-296)

③ Check throttle position sensor. (See page EG1-362)

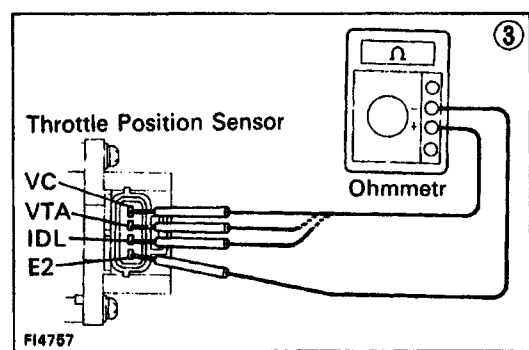
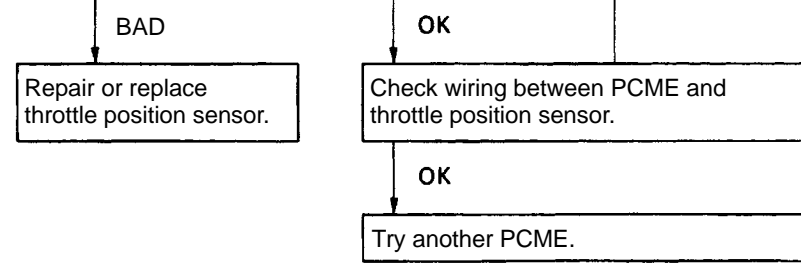

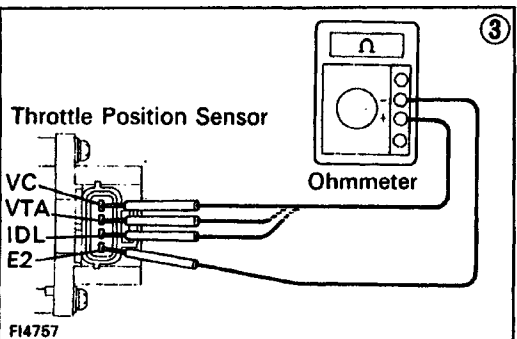
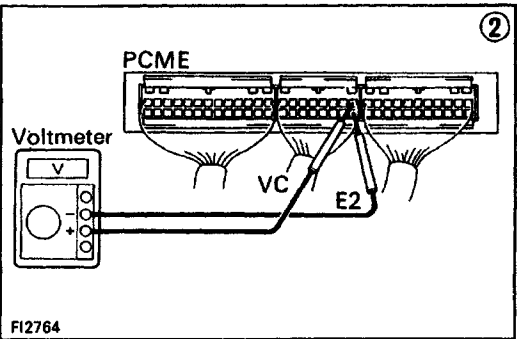
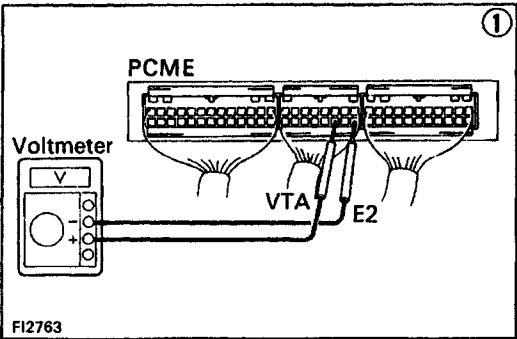
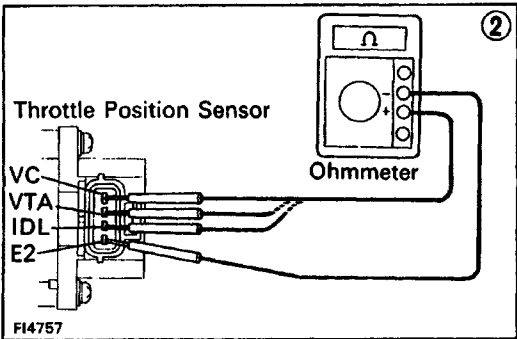
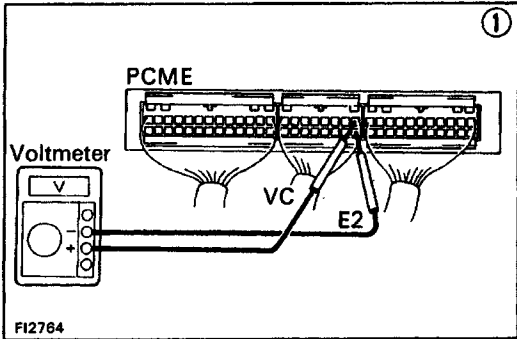

• VC-E2

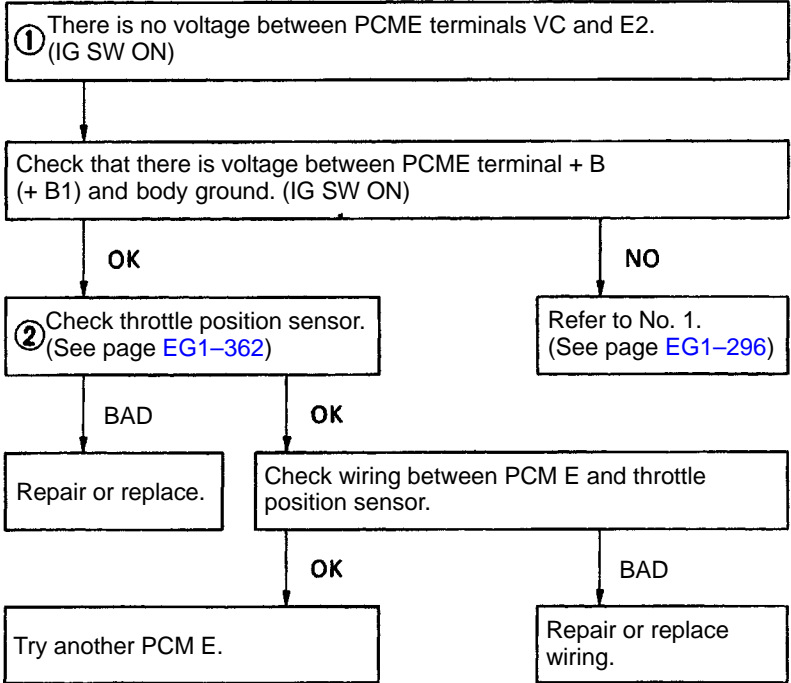

• VTA - et

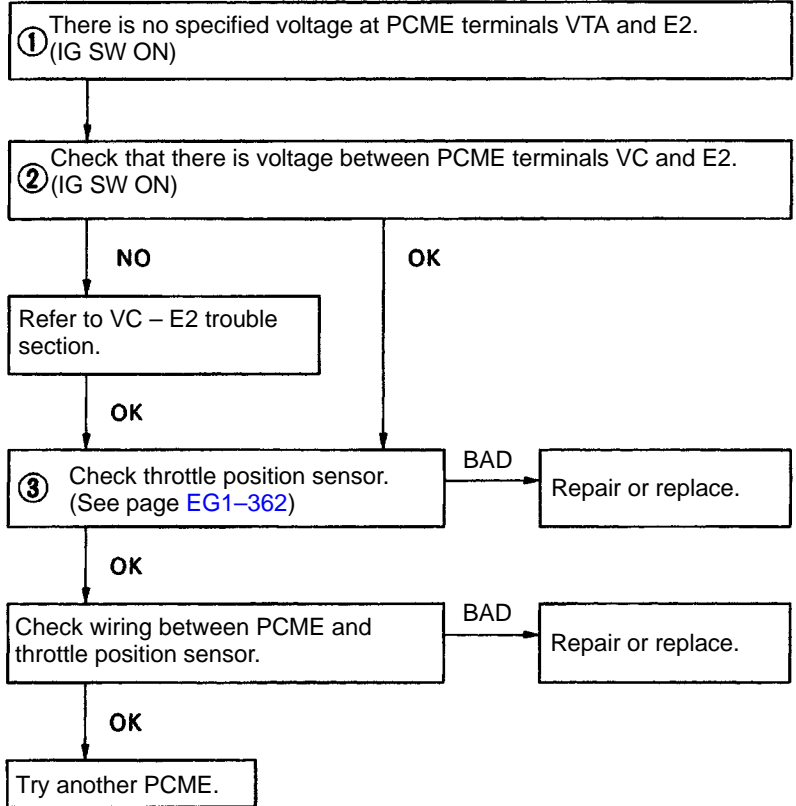

No.	Terminals	Trouble	Condition	STD voltage	
4	VC - E2	No voltage	IG SW ON	-	4.5 - 5.5 V
				Measuring plate fully closed	4.0 - 5.5 V
	VS - E2		Idle	1.6 - 4.1 V	
			3,000 rpm	1.0 - 2.0 V	

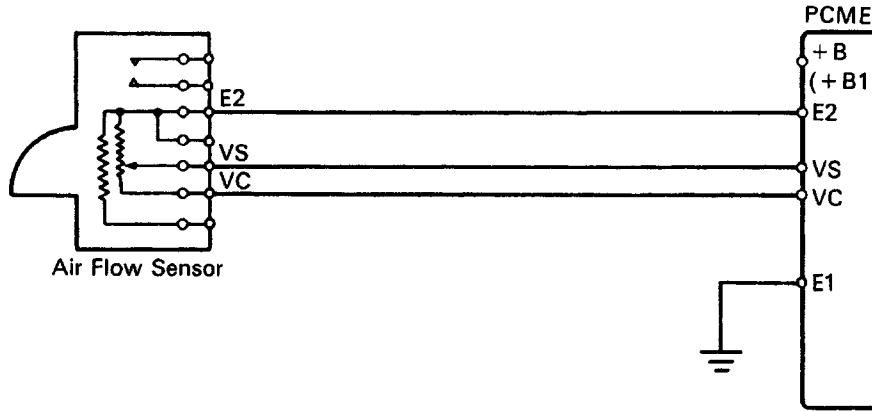

FI6032

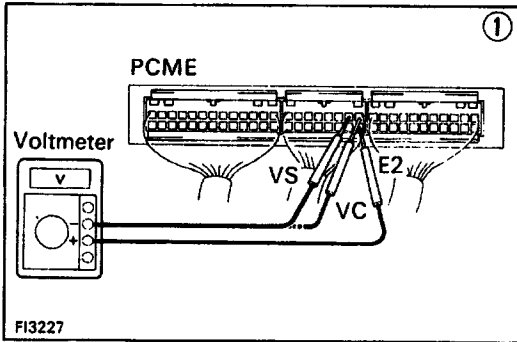

FI3227

1 There is no specified voltage at PCM E terminals VC or VS and E2. (IG SW ON)

2 Check that there is voltage between PCM E terminal + B (+ 131) and body ground. (IG SW ON)

OK

NO

Refer to No. 1. (See page EG1-296)

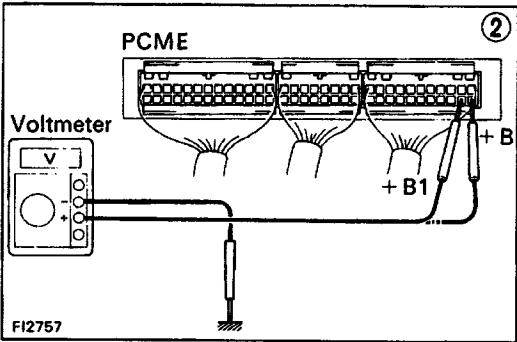

FI2757

Check wiring between PCME terminal E1 and body ground.

OK

BAD

3 Check air flow sensor. (See page EG1-358)

Repair or replace.

BAD

OK

Repair or replace air flow sensor.

Check wiring between PCM E and air flow sensor.

OK

BAD

Try another PCM E.

Repair or replace.

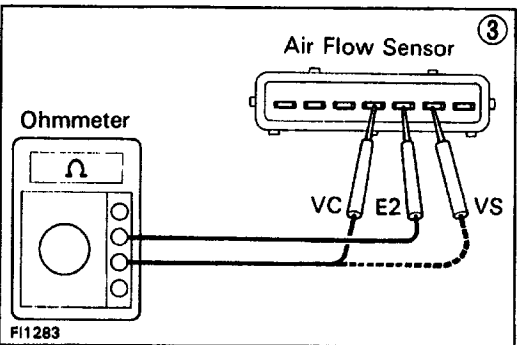

FI1283

No.	Terminals	Trouble	Condition	STD voltage
5	#1 #2 - E01 #3 - E02 #4	No voltage	IG SW ON	9 - 14 V

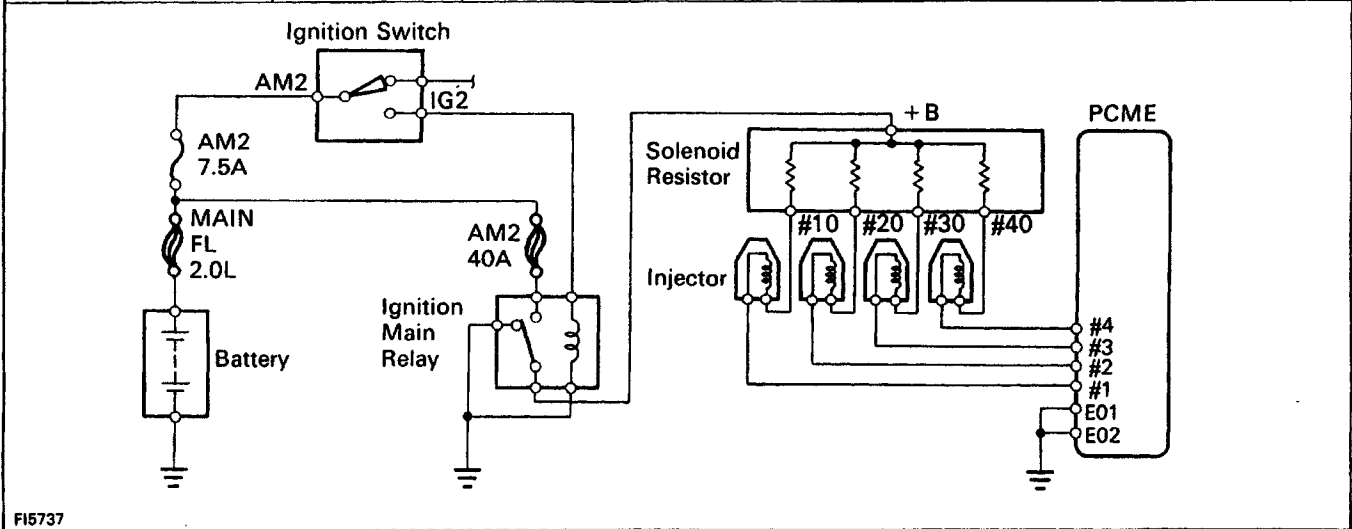

FI5737

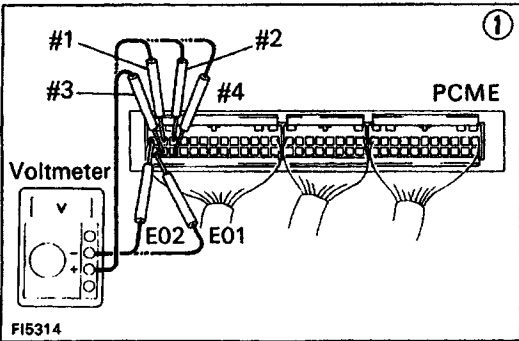

FI5314

There is no voltage between PCME terminals #1, #2, #3 and/or #4 and E01 and/or E02. IG SW ON)

Check that there is specified voltage between solenoid resistor terminal + B and body ground. STD voltage: 9 - 14 V

OK NO

Check fuse, H-fuse, fusible link, wiring, ignition switch and ignition main relay. BAD → Repair or replace.

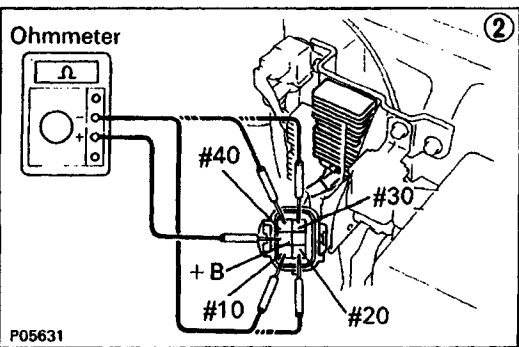

P05631

Check resistance between +B of solenoid resistor and each other terminal. STD resistance: 4 - 6Ω

OK

NO

Check resistance of each injector. STD resistance: 2 - 4Ω

Replace resistor.

OK

BAD

Replace injector.

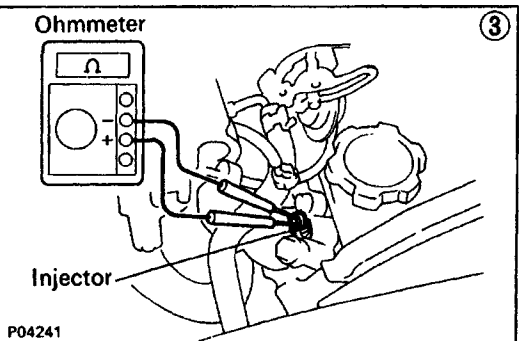

P04241

Check wiring between PCME and resistor. BAD → Repair or replace wiring.

OK

Try another PCME.

No.	Terminals	Trouble	Condition	STD voltage
6	THA - E2	No voltage	IG SW ON Intake air temperature 20°C	0.5 - 3.4 V

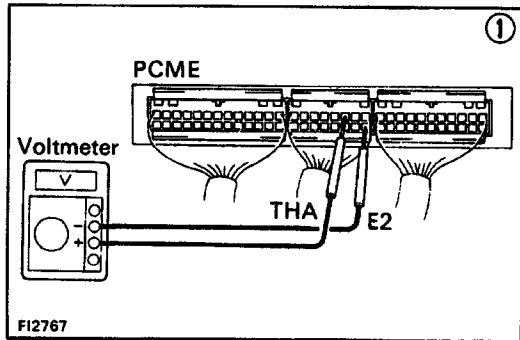
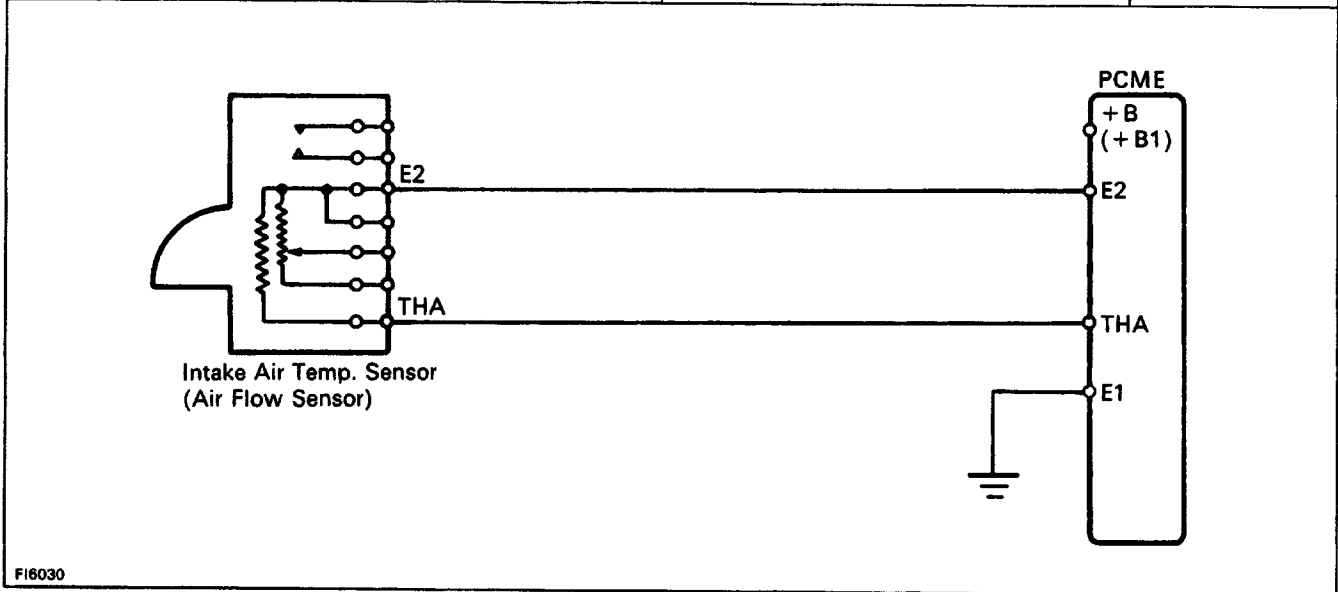

① There is no voltage between PCME terminals THA and E2. (IG SW ON)

② Check that there is voltage between PCME terminal + B (+ 131) and body ground. (IG SW ON)

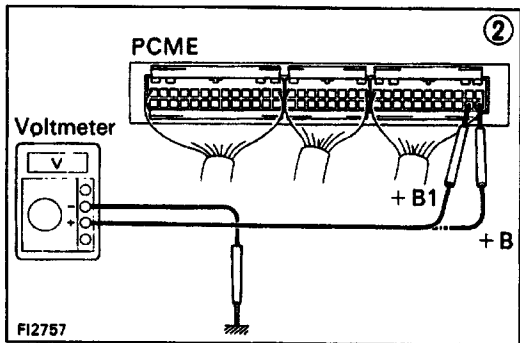

Check wiring between PCME terminal E1 and body ground.

OK

③ Check intake air temp. sensor (See page EG1-358)

BAD

Replace air flow sensor.

NO

Refer to No.1. (See page EG1-296)

BAD

Repair or replace.

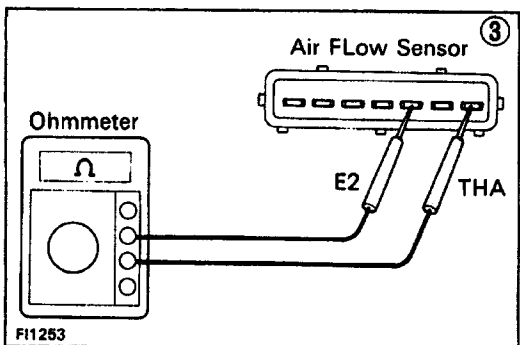

OK

Check wiring between PCME and intake air temp. sensor

OK

Try another PCME.

BAD

Repair or replace.

No.	Terminals	Trouble	Condition		STD voltage
7	THW - E2	No voltage	IG SW ON	Coolant temperature 80°C (176°F)	0.2 - 1.0 V

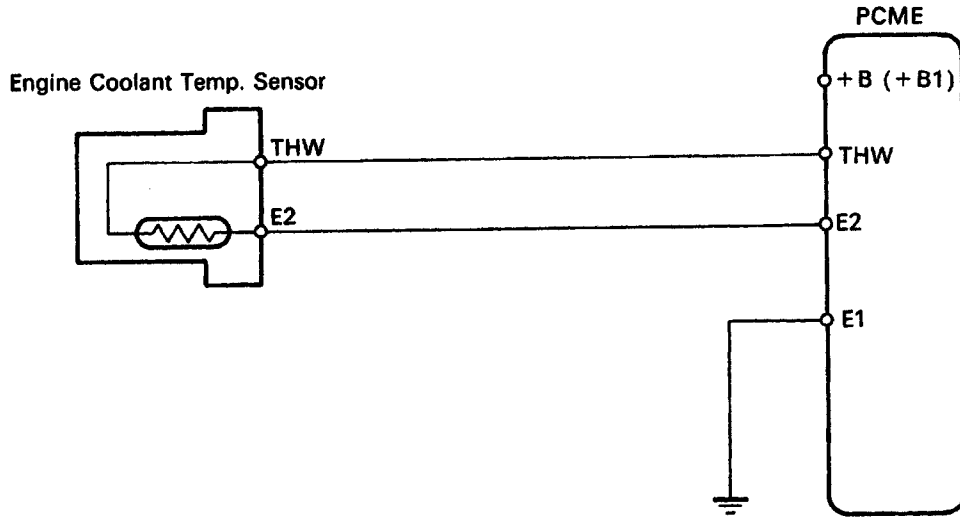

FI3572

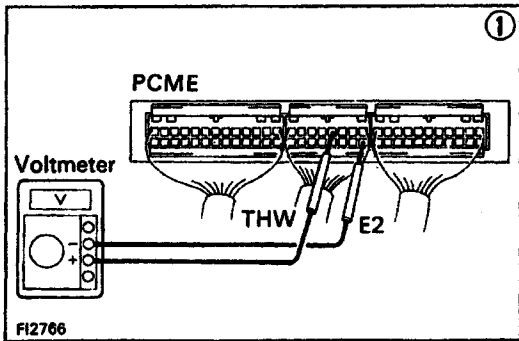

FI2766

① There is no voltage between PCME terminals THW and E2. (IG SW ON)

② Check that there is voltage between PCME terminal + B (+ B1) and body ground. (IG SW ON)

OK

NO

Refer to No.1. (See page EG1-296)

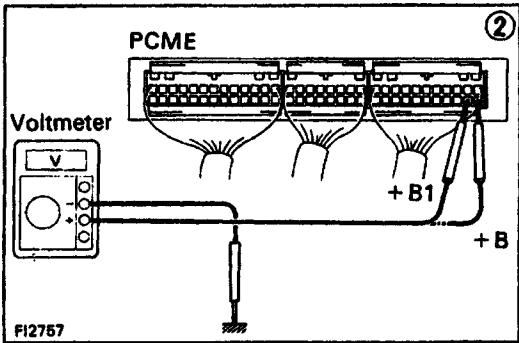

FI2757

Check wiring between PCME terminal E1 and body ground.

OK

BAD

③ Check engine coolant temp. sensor. (See page EG1-378)

Repair or replace.

Replace engine coolant temp. sensor.

Check wiring between PCME and engine coolant temp. sensor.

OK

BAD

Try another PCME.

Repair or replace.

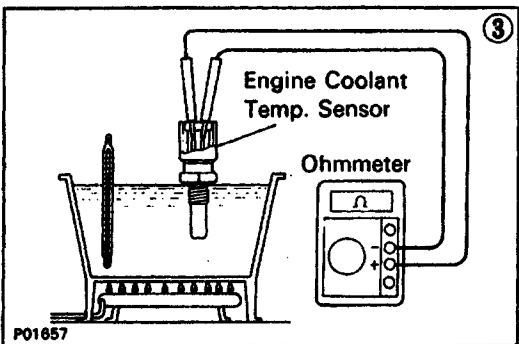

P01657

No.	Terminals	Trouble	Condition	STD voltage
8	STA - E1	No voltage	Cranking	6 V or more

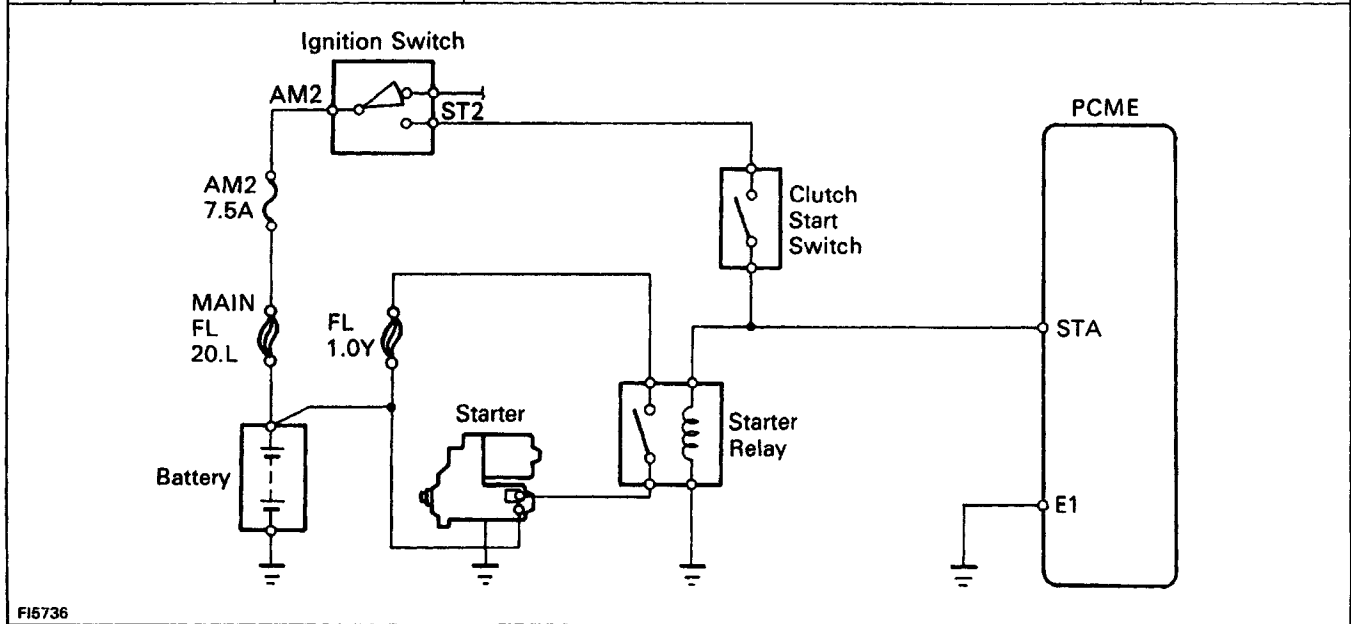

FI5736

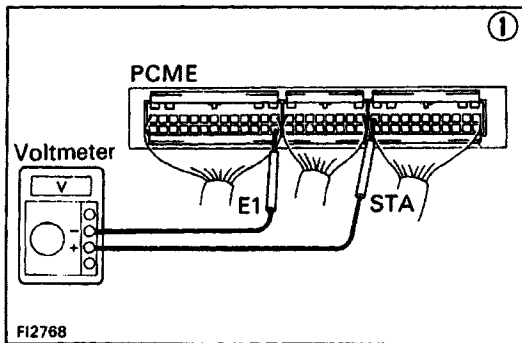

FI2768

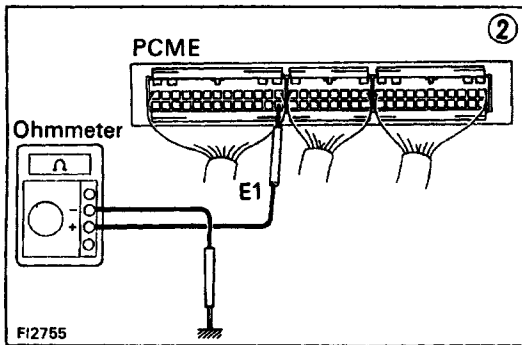

FI2755

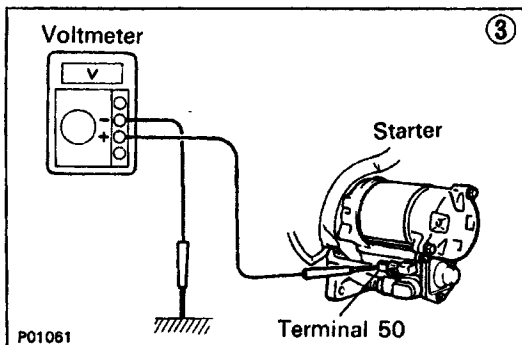

PO1061

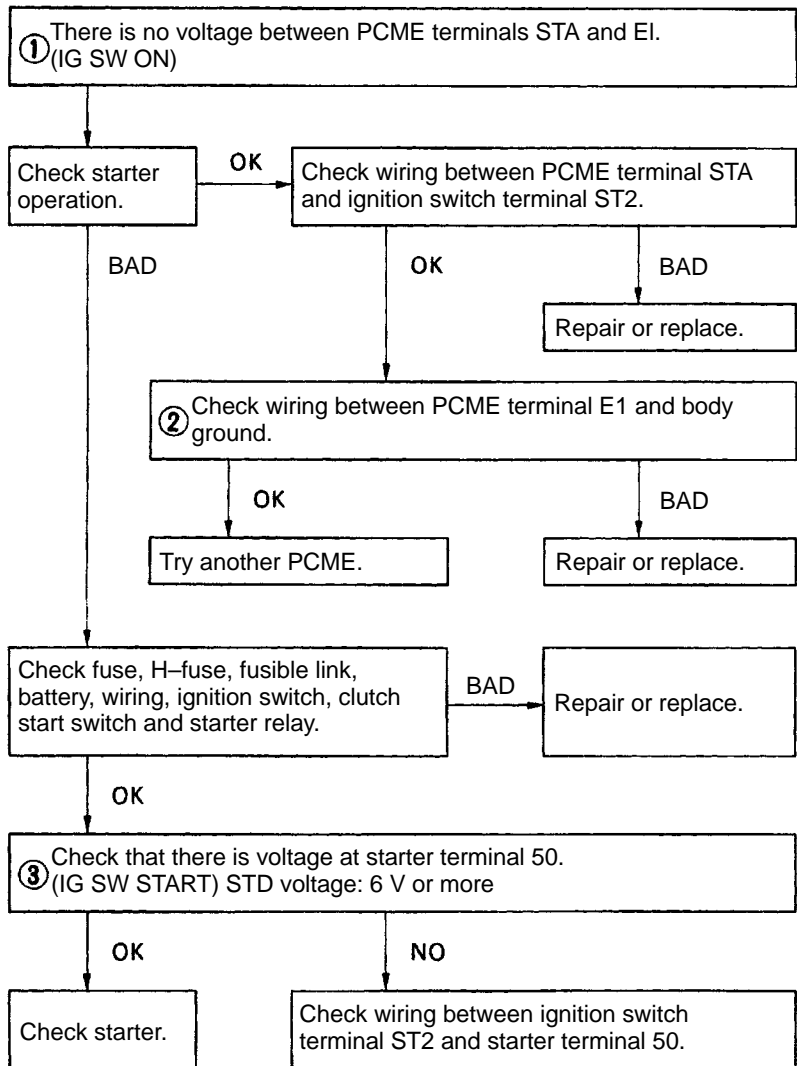

No.	Terminals	Trouble	Condition	STD voltage
9	IGT - E1	No voltage	Idling	Pulse generation

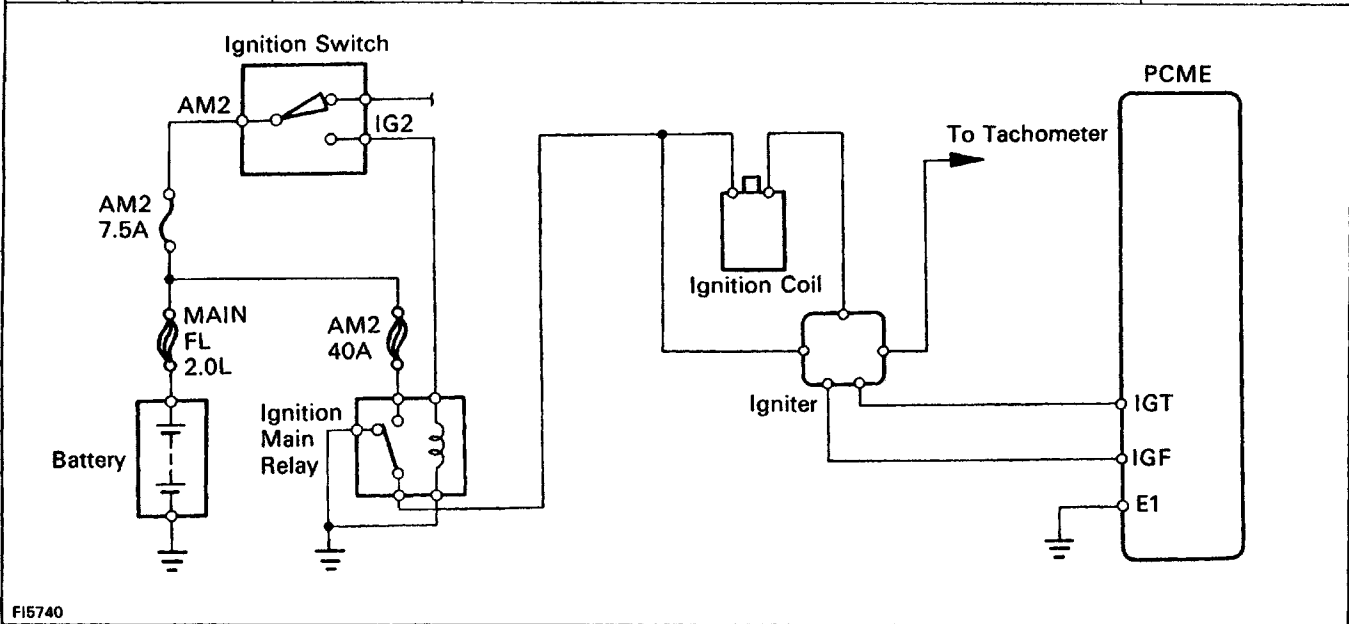

FI5740

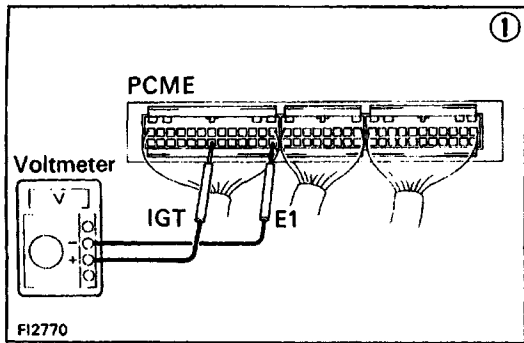

FI2770

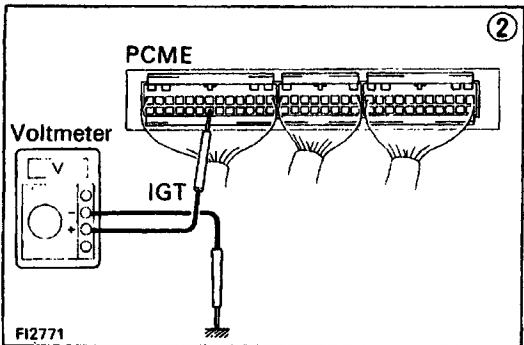

FI2771

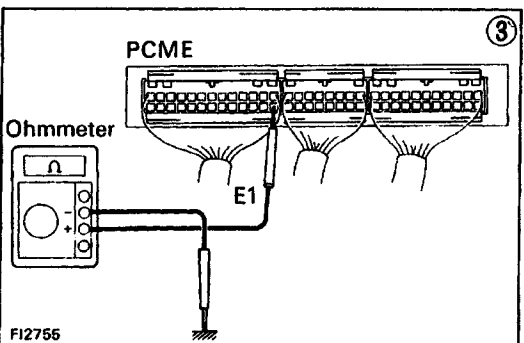

FI2755

```

    graph TD
      Step1["1 There is no voltage between PCME terminals IGT and E1.  
(Idling)"] --> Step2["2 Check that there is voltage between PCME terminal IGT and body  
ground. (idling)"]
      Step2 -- NO --> CheckFuse["Check fuse, H-fuse, fusible link, ignition  
switch and ignition main relay."]
      Step2 -- OK --> CheckE1["Check wiring between PCME  
terminal E1 and body ground."]
      CheckE1 -- BAD --> RepairE1["Repair or  
Replace."]
      CheckE1 -- OK --> TryPCME["Try another PCME."]
      CheckFuse -- BAD --> RepairFuse["Repair or replace."]
      CheckFuse -- OK --> CheckDistributor["Check distributor. (See IG section)"]
      CheckDistributor -- BAD --> RepairDistributor["Repair or replace."]
      CheckDistributor -- OK --> CheckWiring["Check wiring between PCME and  
battery."]
      CheckWiring -- BAD --> RepairWiring["Repair or replace."]
      CheckWiring -- OK --> CheckIgniter["Check igniter. (See IG section)"]
      CheckIgniter -- BAD --> RepairIgniter["Repair or replace."]
  
```

No.	Terminals	Trouble	Condition		STD voltage
10	RSC RSO - E1	No voltage	IG SW ON	PCME connectors disconnected	9 - 14 V

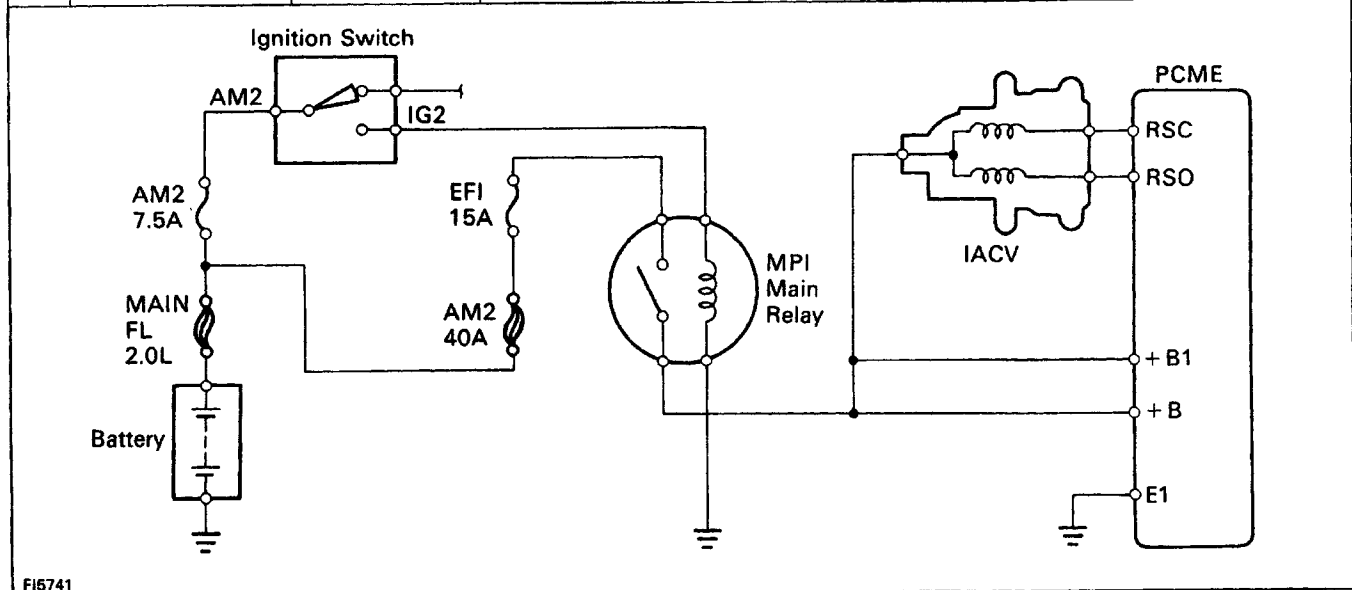

FI5741

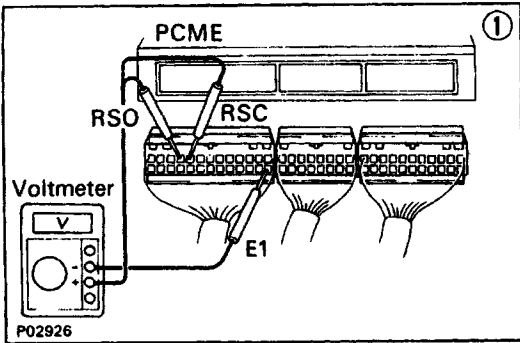

P02926

① There is no voltage between PCME terminals RSC or RSO and E1. (IG SW ON)

② Check that there is voltage between PCME terminal + B (+ B1) and body ground. (IG SW ON)

OK

NO

Refer to No-1. (See page EG1-296)

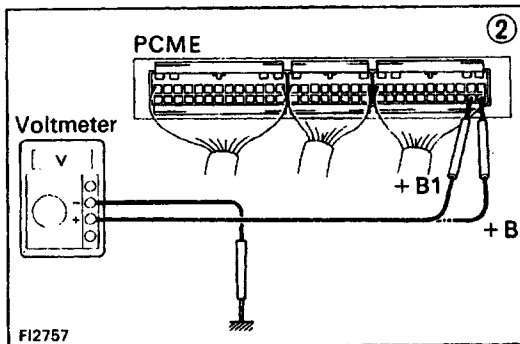

FI2757

③ Check resistance between IACV terminals + B and RSC or RSO. STD resistance: 17.7 - 23.9 Ω

BAD

Replace IACV.

OK

Check wiring between PCME and IACV.

BAD

Repair or replace wiring.

OK

Try another PCME.

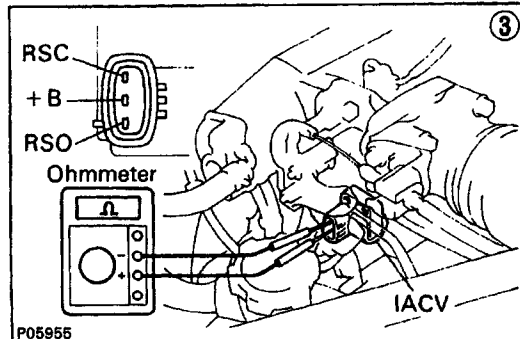

P05955

No.	Terminals	Trouble	Condition	STD voltage
11	W - E1	No voltage	No trouble ("CHECK" engine warning light off) and engine running.	9 - 14 V

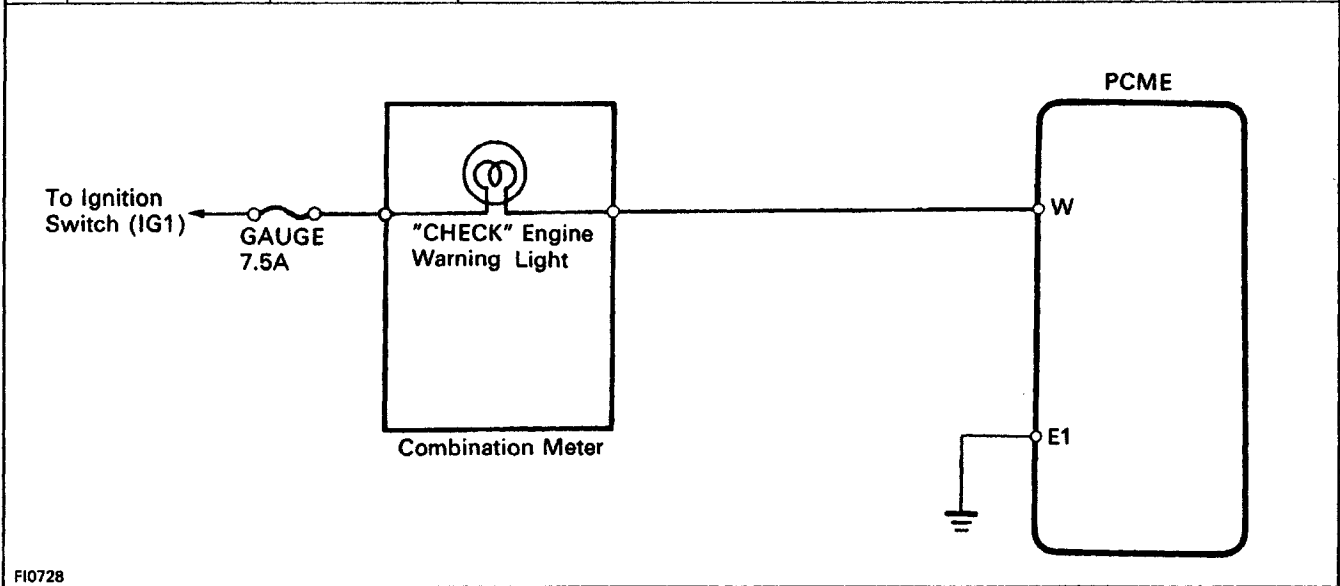

FI0728

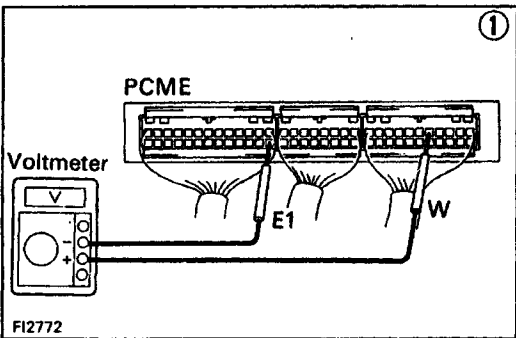

FI2772

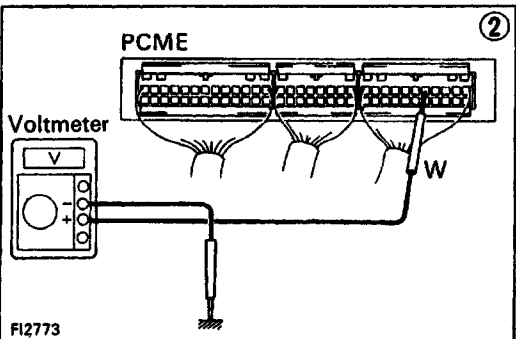

FI2773

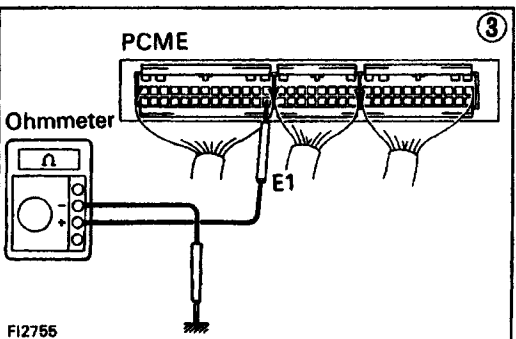

FI2755

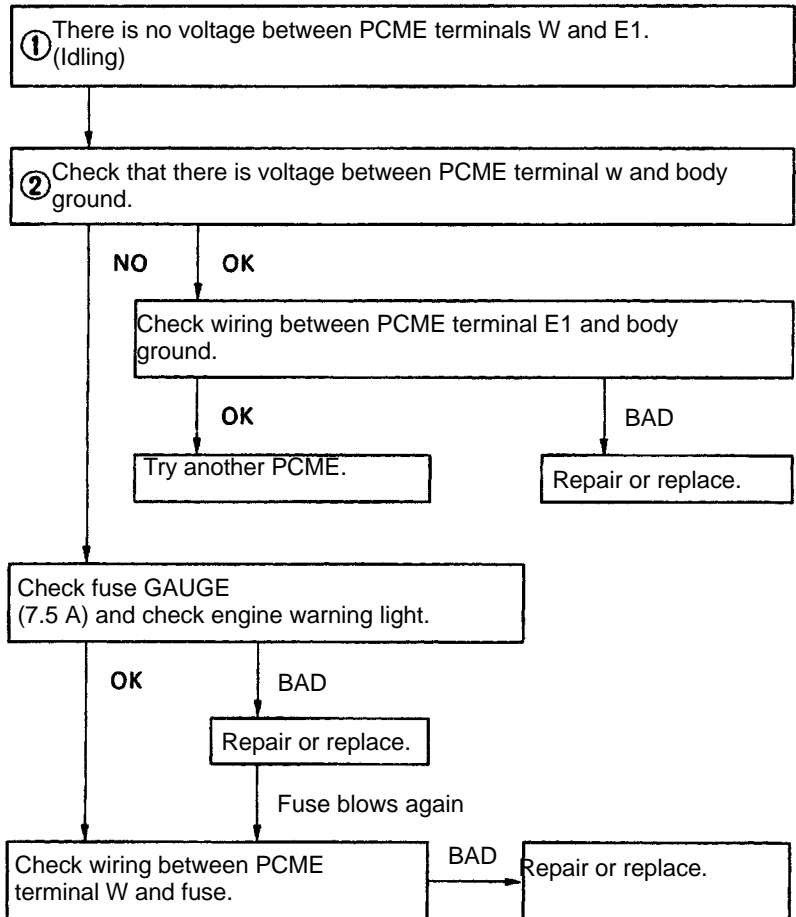

No.	Terminals	Trouble	Condition	STD voltage
12	PIM - E2	No voltage	IG SW ON	2.5 - 4.5 V
	VC - E2			4.5 - 5.5 V

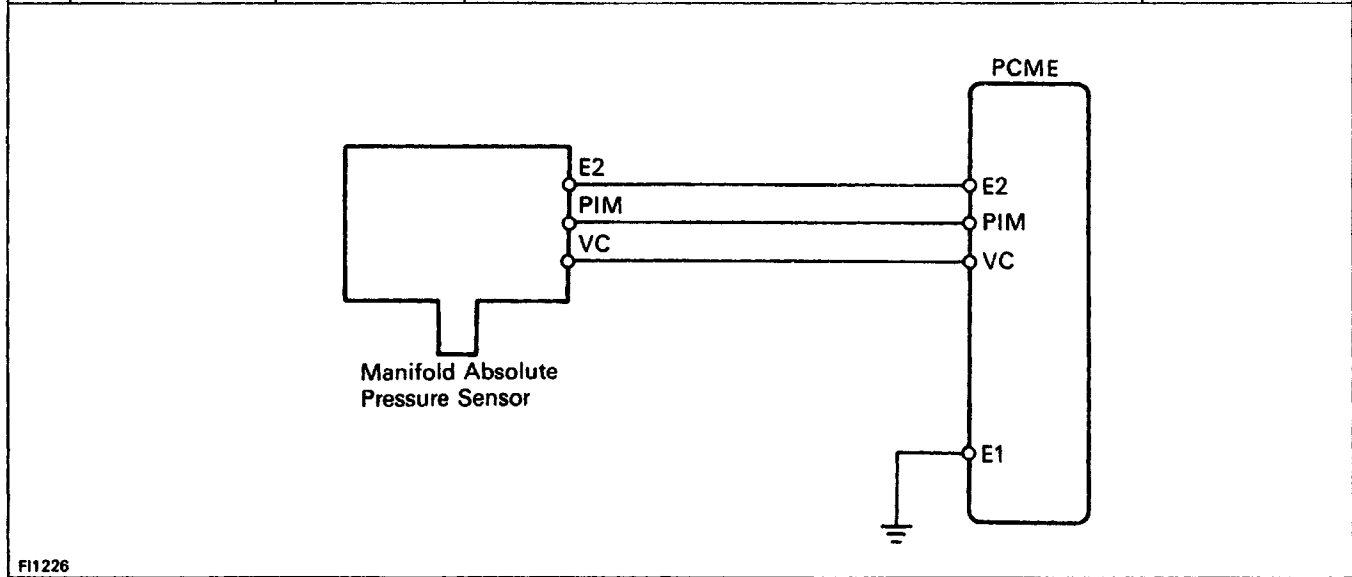

FI1226

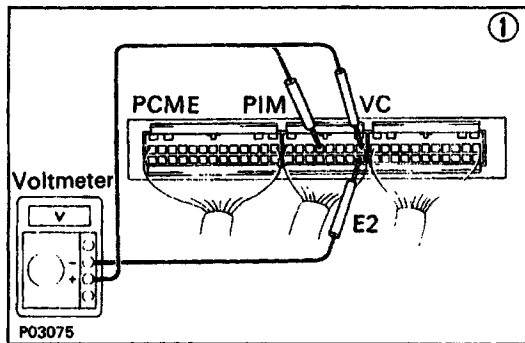

① There is no voltage between PCME terminals PIM or VC and E2. (IG SW ON)

② Check that there is voltage between PCME terminal + B or + 131 and body ground. (OG SW ON)

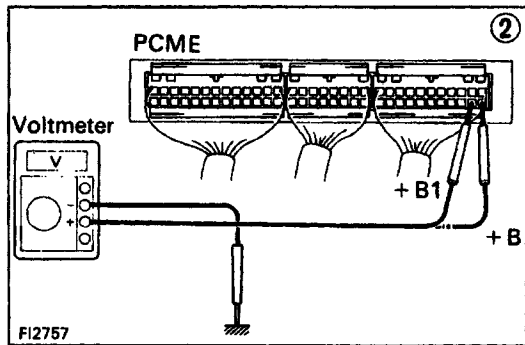

③ Check wiring between PCME terminal E1 and body ground.

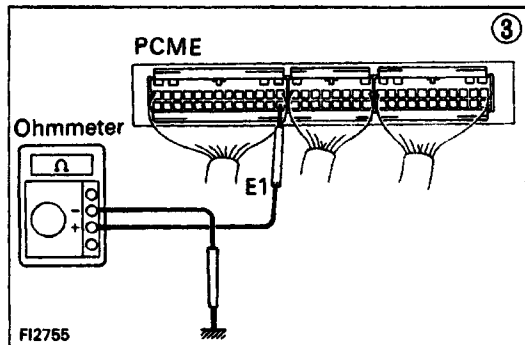

OK

NO

Refer to No.1. (See page EG1-296)

OK

BAD

Check manifold absolute pressure sensor. (See page EG1-400)

Repair or replace.

BAD

OK

Replace manifold absolute pressure sensor.

Check wiring between PCME and manifold absolute pressure sensor.

OK

BAD

Try another PCME.

Repair or replace.

No.	Terminals	Trouble	Condition	STD voltage
13	AC - E1	No voltage	Air conditioning ON	9 - 14 V

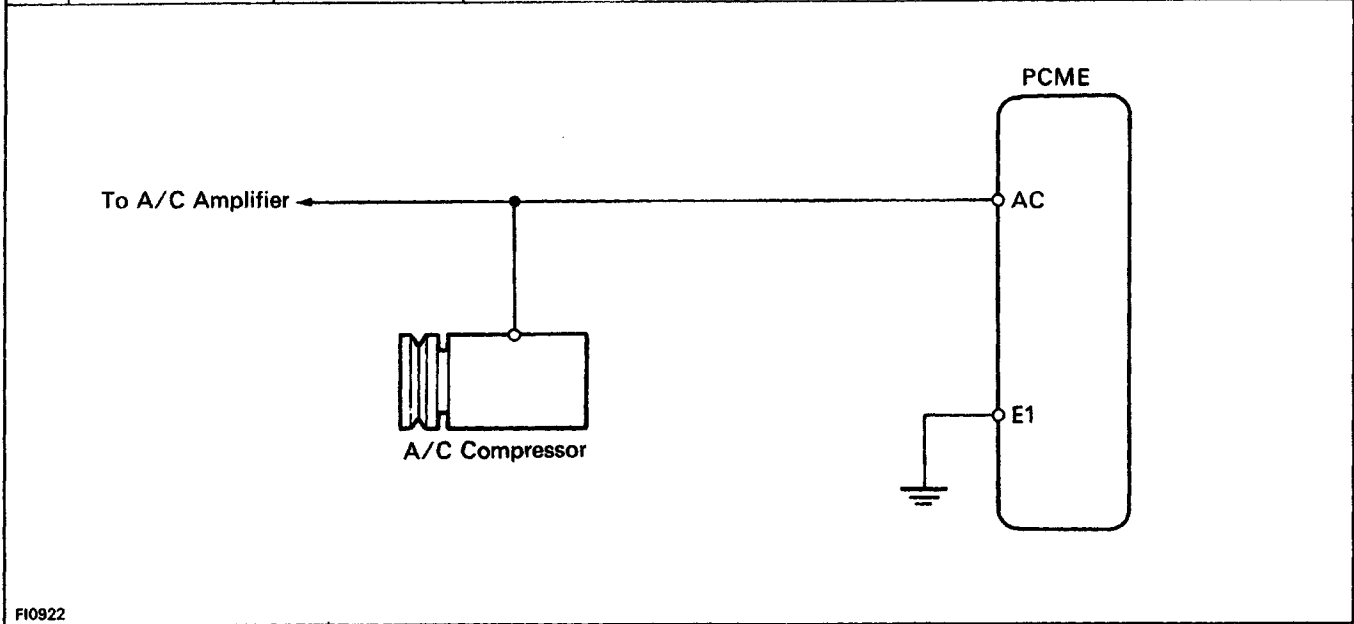

FI0922

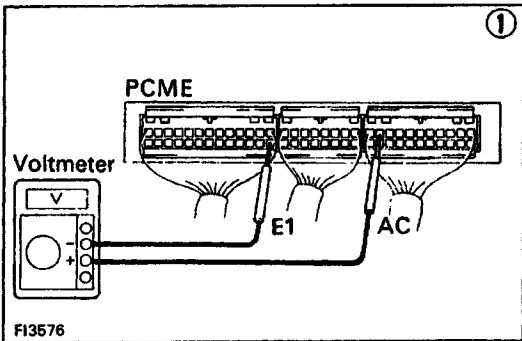

FI3576

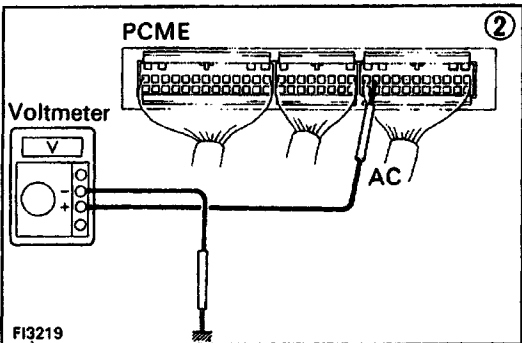

FI3219

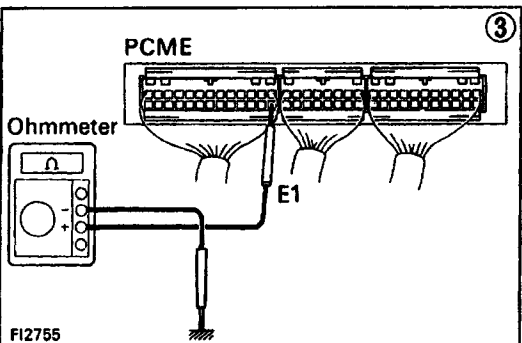

FI2755

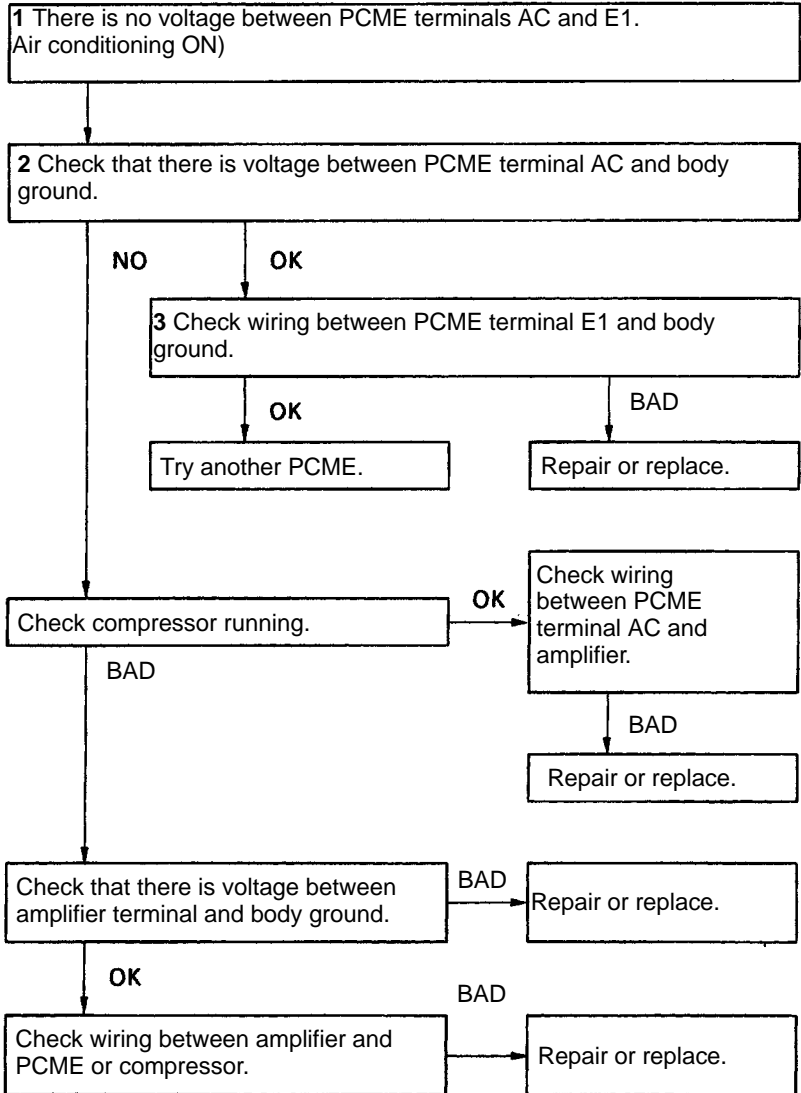

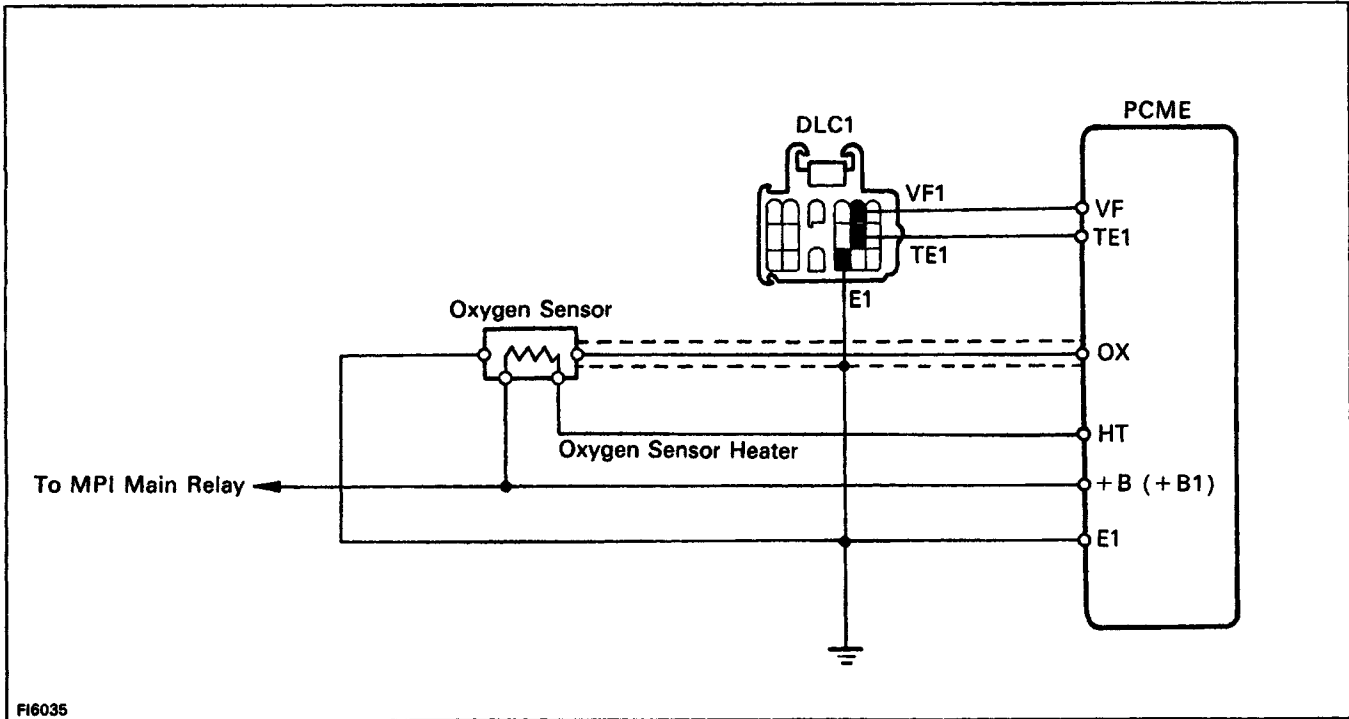

FI6035

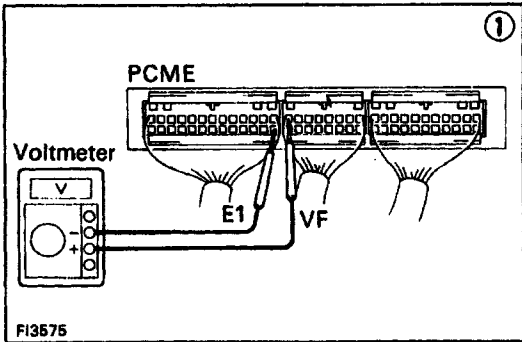

FI3575

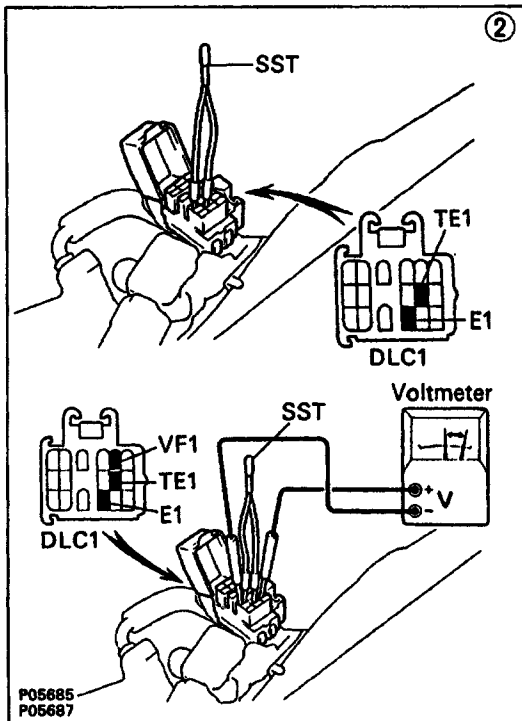

P05685
P05687

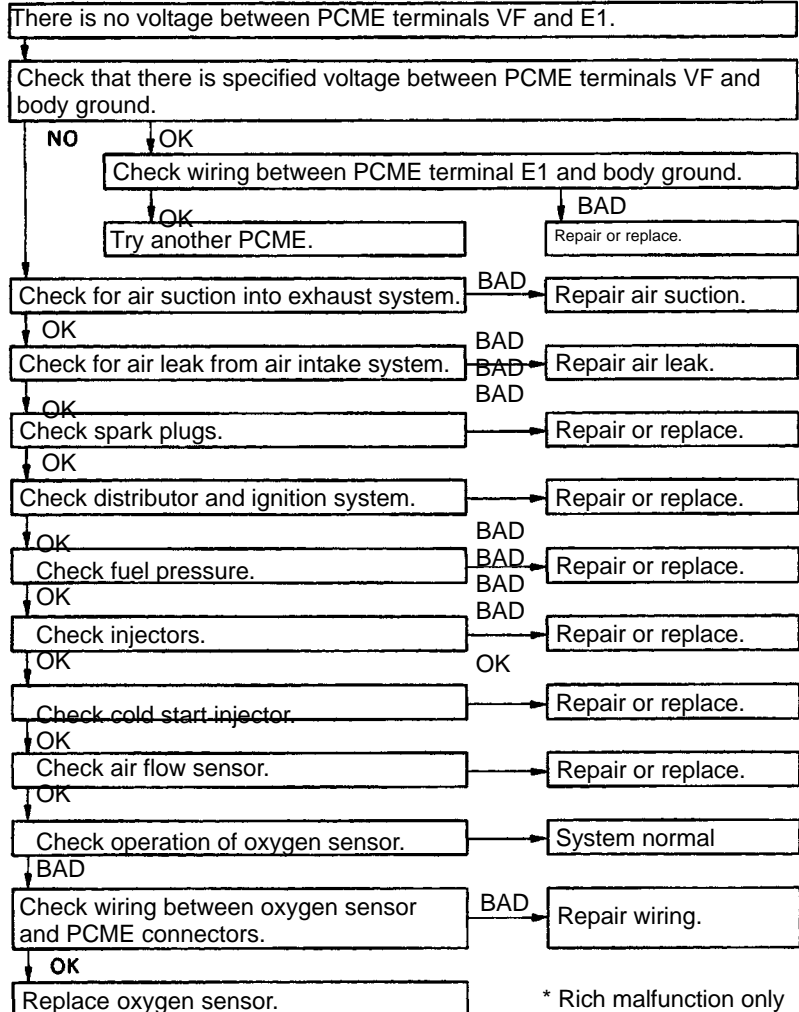

* Rich malfunction only

Calif. only

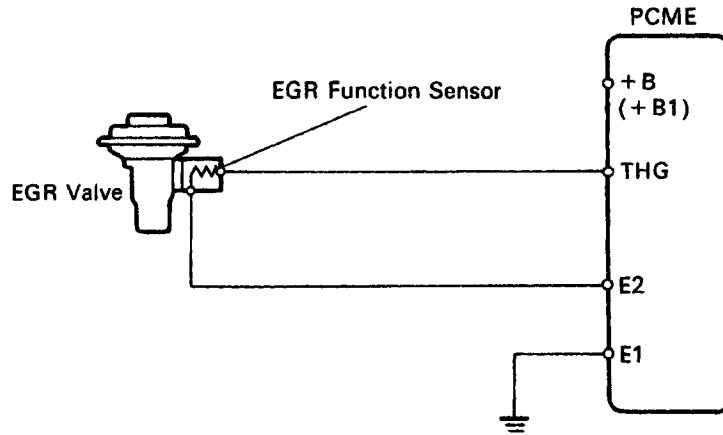

FI2680

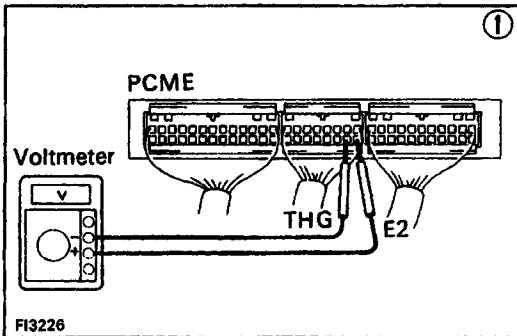

FI3226

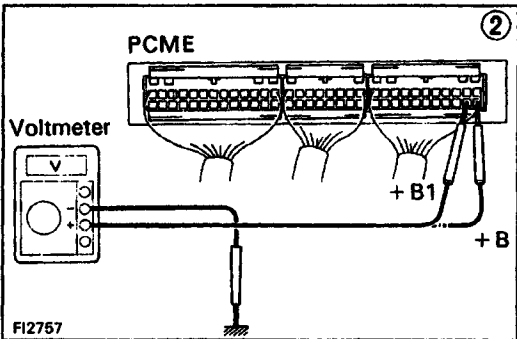

FI2757

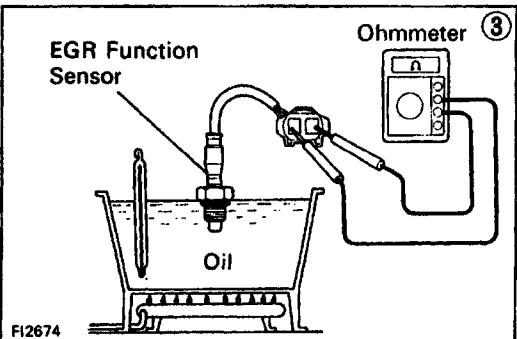

FI2674

