

FUEL PUMP

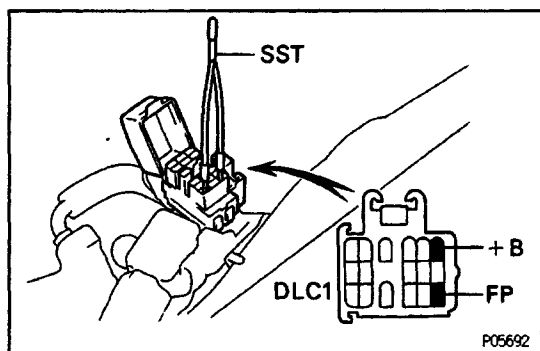
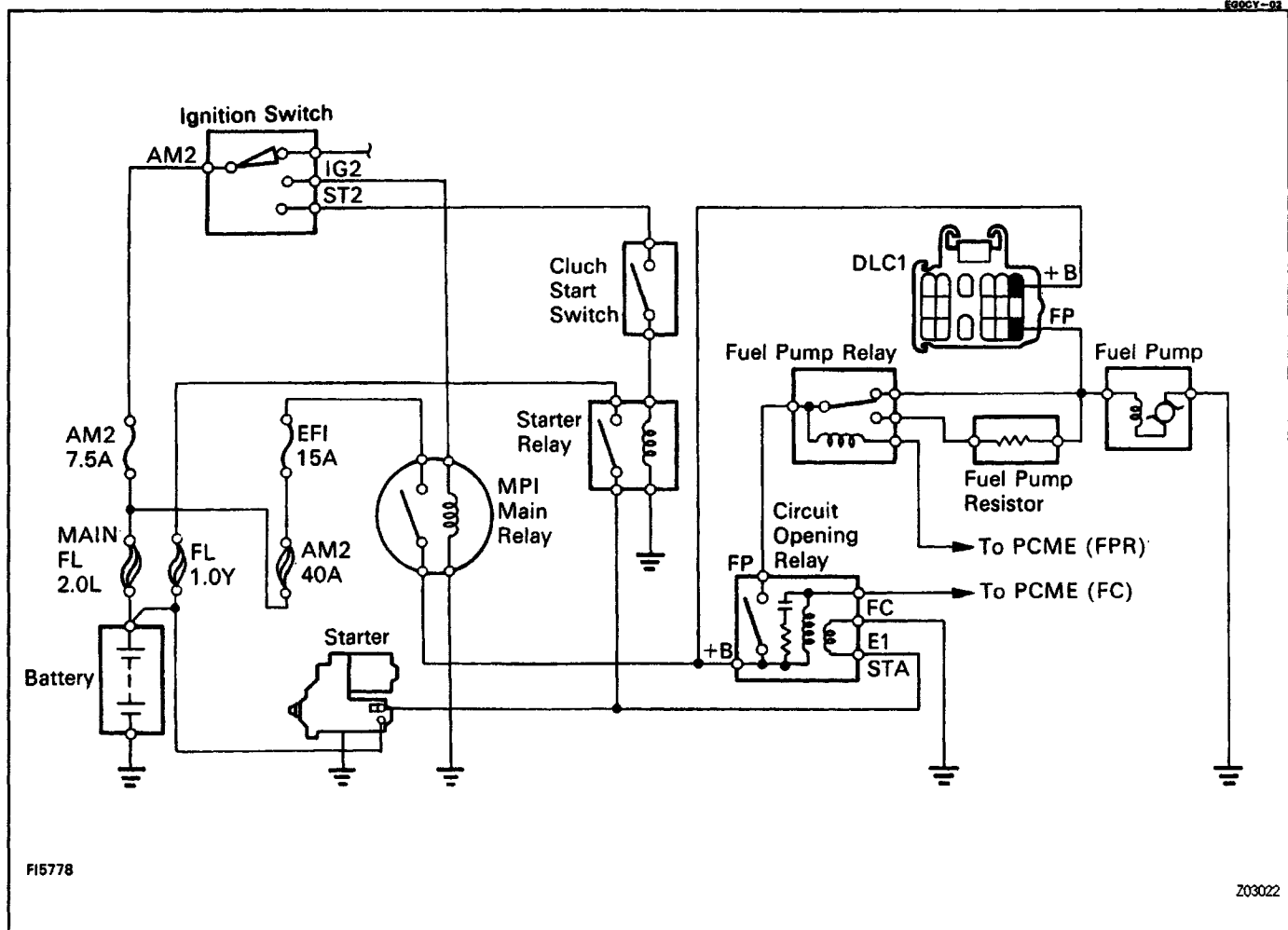

ON-VEHICLE INSPECTION

1. CHECK FUEL PUMP OPERATION

(a) Using SST, connect terminals +B and FP of the data link connector 1.

SST 09843-18020

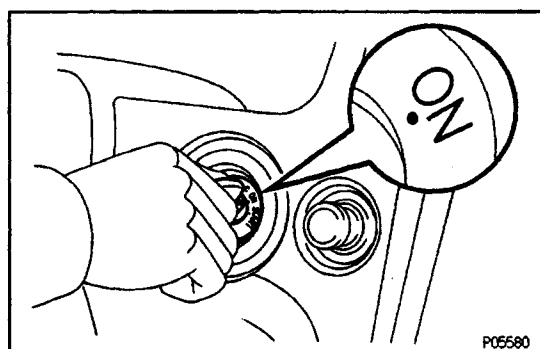

(b) Turn the ignition switch ON.

NOTICE: Do not start the engine.

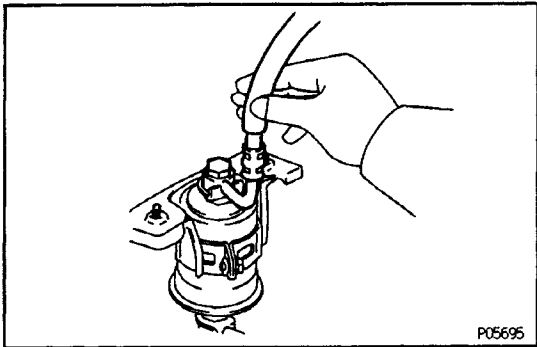

- (c) Check that there is pressure in the hose from the fuel filter.

HINT: At this time, you will hear fuel return noise.

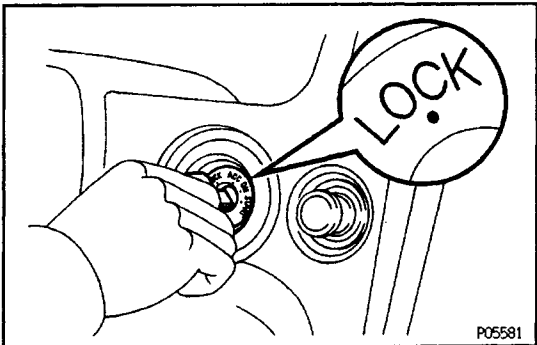

- (d) Turn the ignition switch OFF.

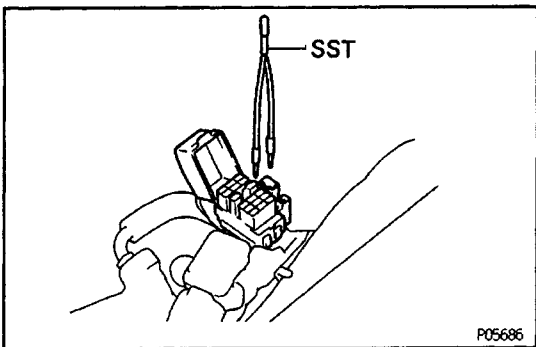

- (e) Remove the SST from the data link connector 1.
SST 09843-18020

If there is no pressure, check the following parts:

- Fusible links (2.OL, 1.OY)
- H-fuse (AM2 40A)
- Fuses (EFI 15A, AM2 7.5A)
- MPI main relay
- Fuel pump
- Fuel pump relay
- Fuel pump resistor
- Wiring connections

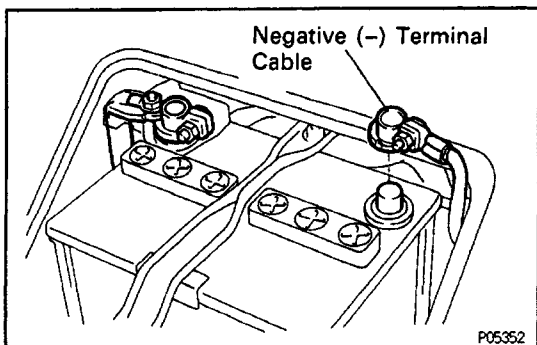

2. CHECK FUEL PRESSURE

- (a) Check that the battery voltages is above 12 volts.
(b) Disconnect the cable from the negative (-) terminal of the battery.

CAUTION: Turn the ignition switch to "LOCK". Disconnect the negative terminal from the battery. Wait at least 20 seconds before proceeding with work.

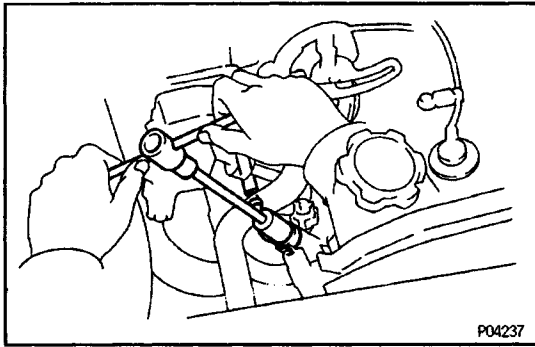

- (c) Remove the union bolt and two gaskets, and disconnect the fuel inlet hose from the delivery pipe.

HINT:

Put a suitable container or shop towel under the delivery pipe.

- Slowly loosen the union bolt.

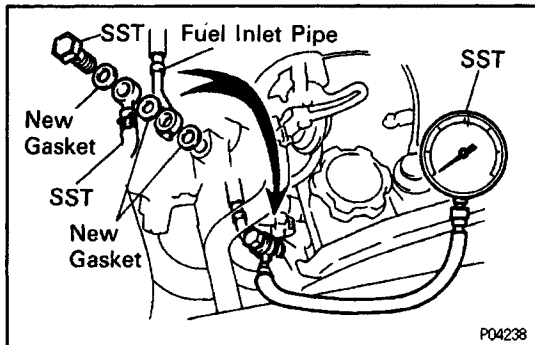

- (d) Install the fuel inlet hose and SST (pressure gauge) to the delivery pipe with three new gaskets and SST (union bolt).

SST 09268-45012

Torque: 29 N-m (300 kgf-cm, 22 ft-lbf)

- (e) Wipe off any splattered gasoline.

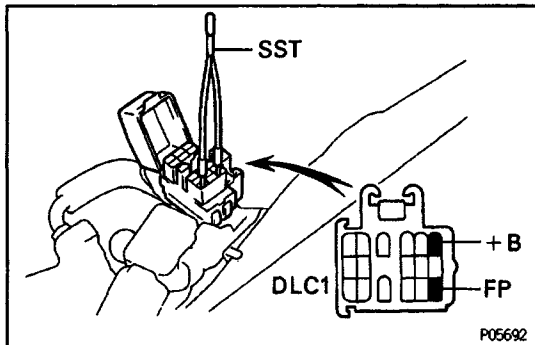

- (f) Using SST, connect terminals +B and FP of the data link connector 1.

SST 09843-18020

- (g) Reconnect the battery negative (-) cable.

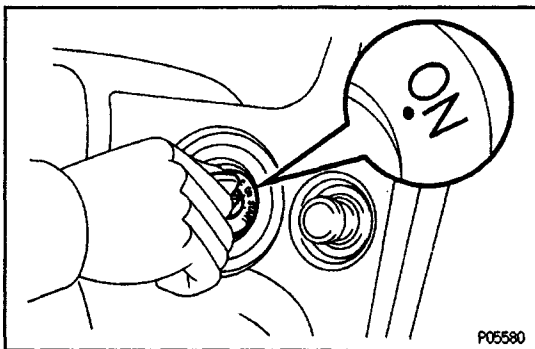

- (h) Turn the ignition switch ON.

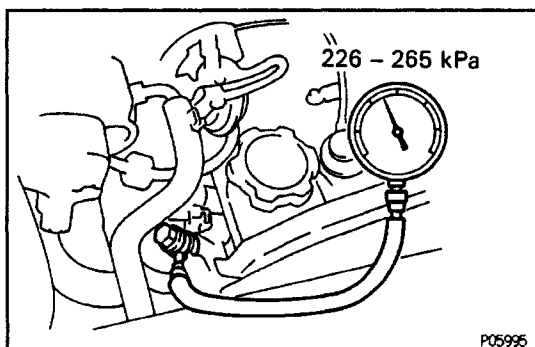

- (i) Measure the fuel pressure.

Fuel pressure:

226 - 265 kPa (2.3 - 2.7 kgf/cm², 33 - 38 psi)

If pressure is high, replace the fuel pressure regulator.

If pressure is low, check the following parts:

- Fuel hoses and connections
- Fuel pump
- Fuel filter
- Fuel pressure regulator

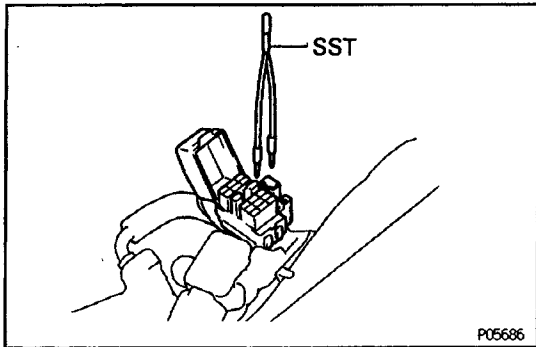

- (j) Remove the SST from the data link connector 1.
SST 09483-18020

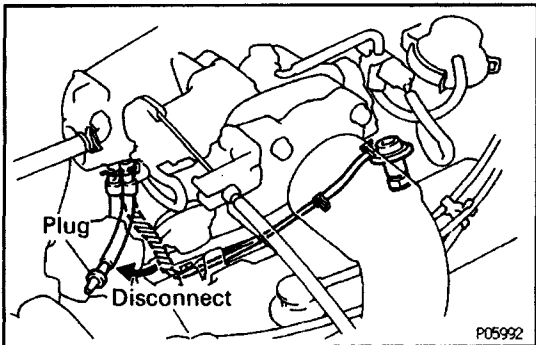

- (k) Start the engine.
(l) Disconnect the vacuum sensing hose from the air intake chamber and plug the air intake chamber outlet.

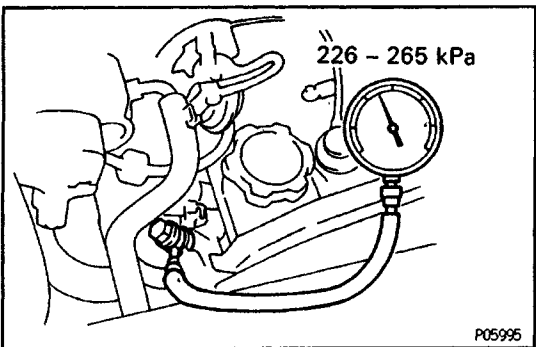

- (m) Measure the fuel pressure at idle.
Fuel pressure:
226 - 265 kPa (2.3 - 2.7 kgf/cm², 33 - 38 psi)

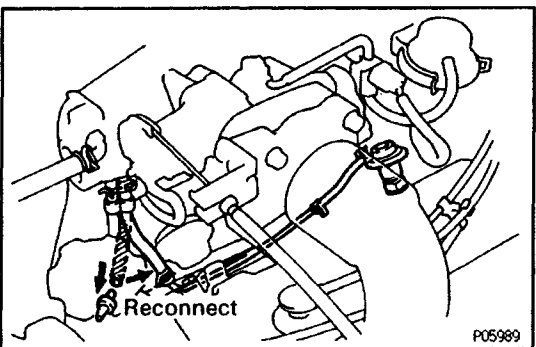

- (n) Reconnect the vacuum sensing hose to the air intake chamber.

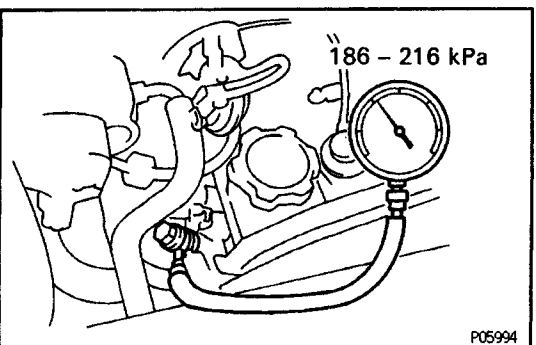

- (o) Measure the fuel pressure at idle.
Fuel pressure:
186 - 216 kPa (1.9 - 2.2 kgf/cm², 27 - 31 psi)
If pressure is not as specified, check the vacuum sensing hose and fuel pressure regulator.

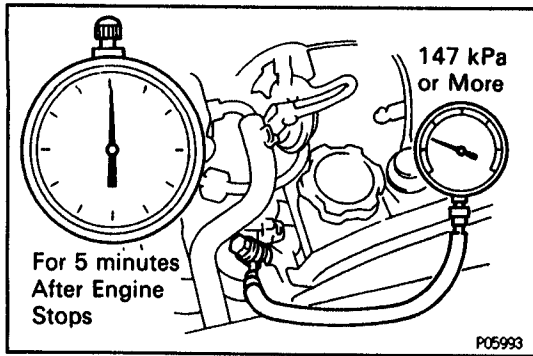

- (P) Stop the engine.
- (q) Check that the fuel pressure remains as specified for 5 minutes after the engine stops.

Fuel pressure:

147 kPa (1.5 kgf/cm², 21 psi) or more

If pressure is not as specified, check the fuel pump, pressure regulator and/or injector.

- (r) After checking fuel pressure, disconnect the battery negative (-) cable and carefully remove the SST to prevent gasoline from splashing.
SST 09268-45012

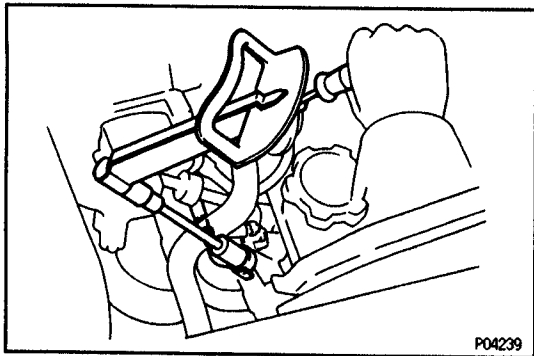

- (s) Connect the fuel inlet hose to the delivery pipe with two new gaskets and the union bolt.
Torque: 29 N-m (300 kgf-cm, 22 ft-lbf)

- (t) Reconnect the cable to the negative (-) terminal of the battery.
- (u) Check for fuel leaks.

COMPONENTS FOR REMOVAL AND INSTALLATION

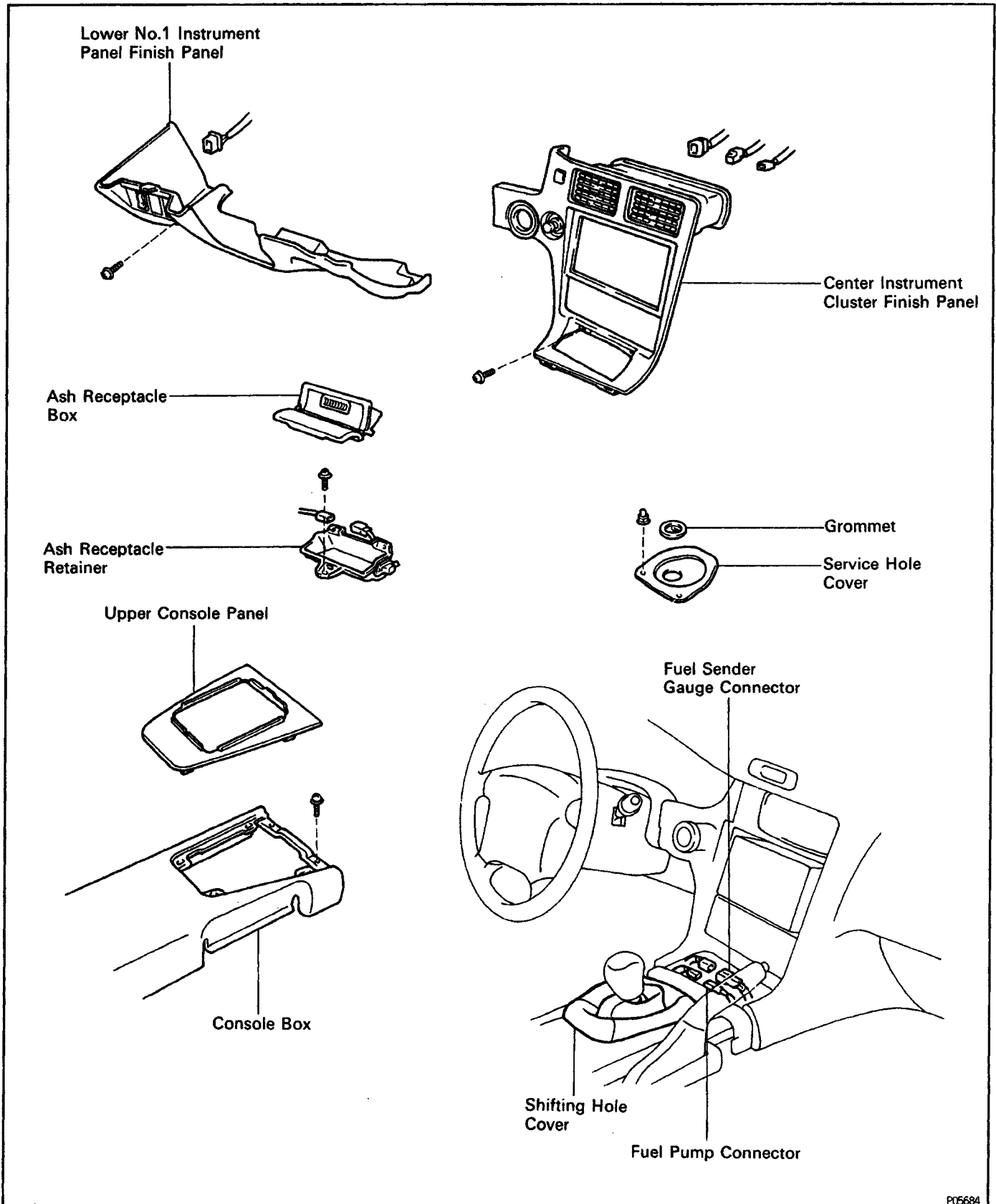

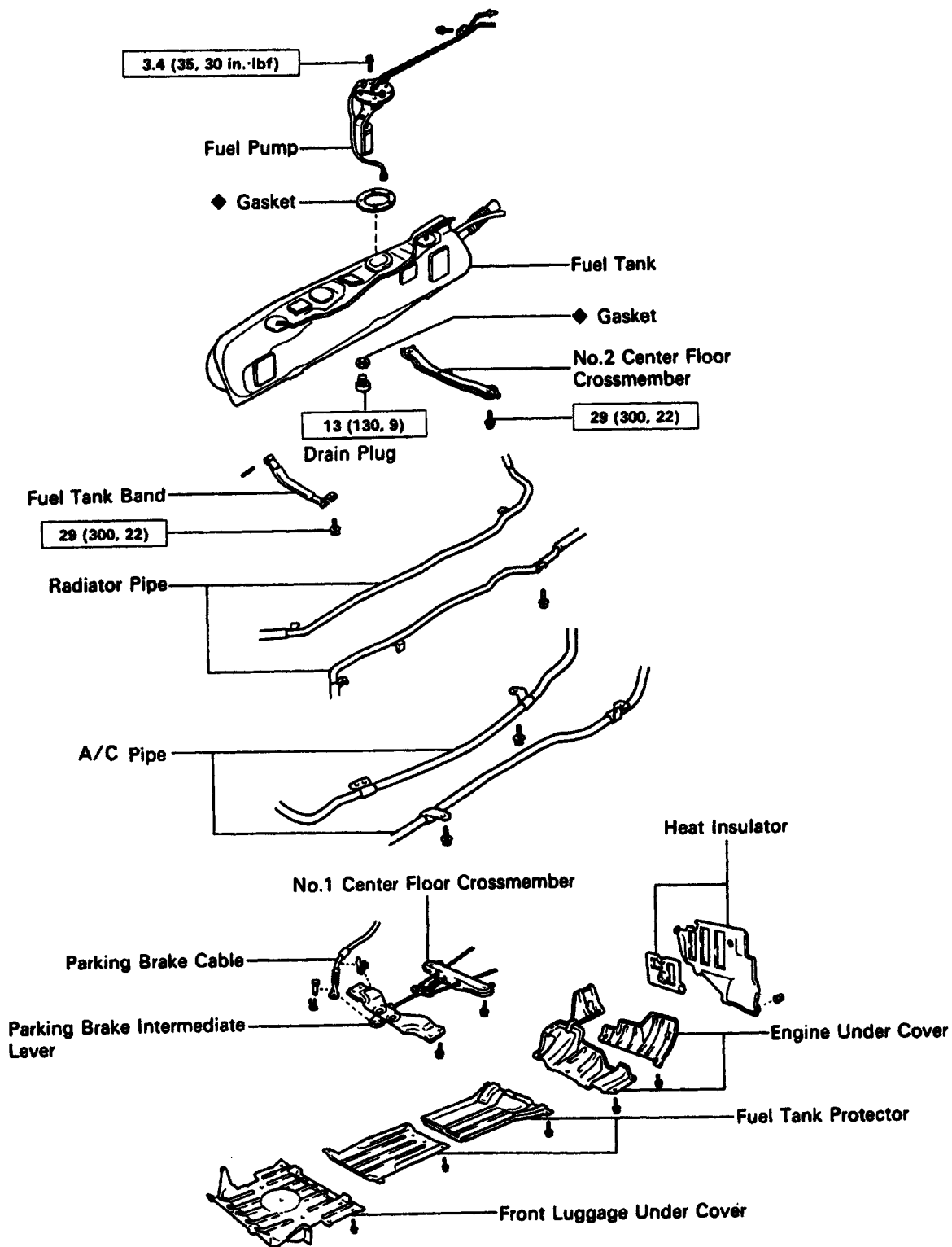

N·m (kgf·cm, ft·lbf) : Specified torque

◆ Non-reusable part

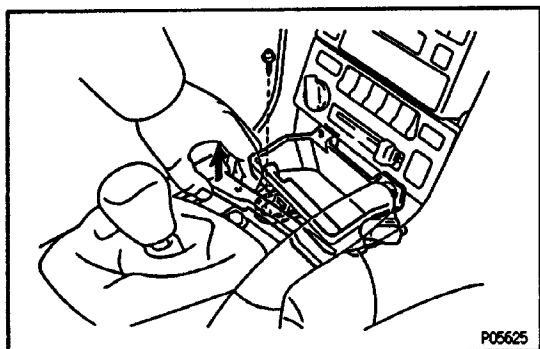

FUEL PUMP INSPECTION

(See Components for Removal and Installation)

1. REMOVE ASH RECEPTACLE RETAINER
(See steps 1 and 2 in Fuel Pump Removal)
2. DISCONNECT FUEL PUMP CONNECTOR

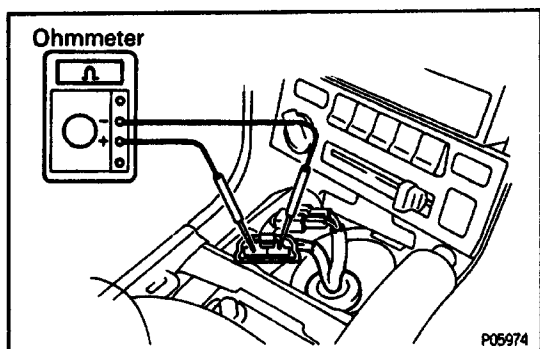

3. INSPECT FUEL PUMP

A. Inspect fuel pump resistance

Using an ohmmeter, measure the resistance between the terminals.

Resistance (Cold):

0.2–3.00

If the resistance is not as specified, replace the fuel pump.

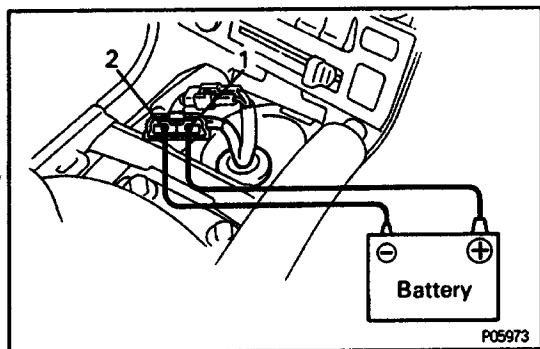

B. Inspect fuel pump operation

Connect the positive (+) lead from the battery to terminal 1 of the connector, and the negative (-) lead to terminal

2. Check that the fuel pump operates.
If operation is not as specified, replace the fuel pump.

NOTICE:

- These tests must be performed quickly (within 10 seconds) to prevent the coil from burning out.
- Keep the fuel pump as far away from the battery as possible. .
- Always perform switching at the battery side.

4. RECONNECT FUEL PUMP CONNECTOR

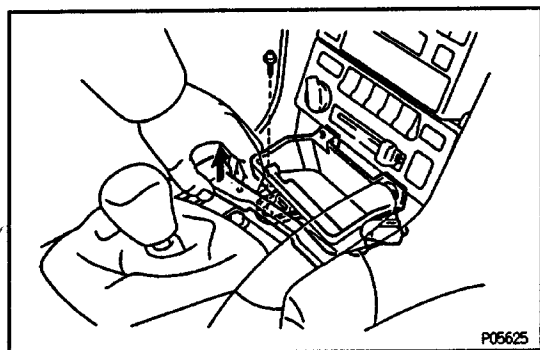

6. REINSTALL ASH RECEPTACLE RETAINER
(See steps 7 and 9 in Fuel Pump Installation)

FUEL PUMP REMOVAL

(See Components for Removal and Installation)

CAUTION: Do not smoke or work near an open flame when working on the fuel pump.

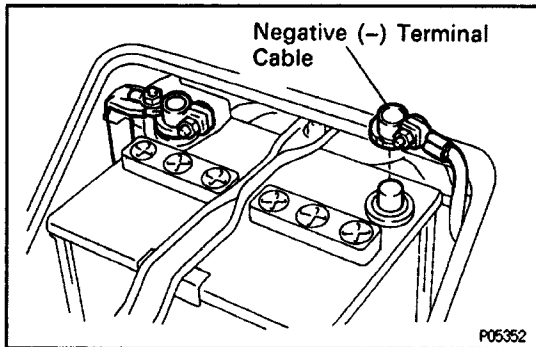

1. DISCONNECT CABLE FROM NEGATIVE TERMINAL OF BATTERY

CAUTION: Turn the ignition switch to 'LOCK'. Disconnect the negative terminal from the battery. Wait at least 20 seconds before proceeding with work.

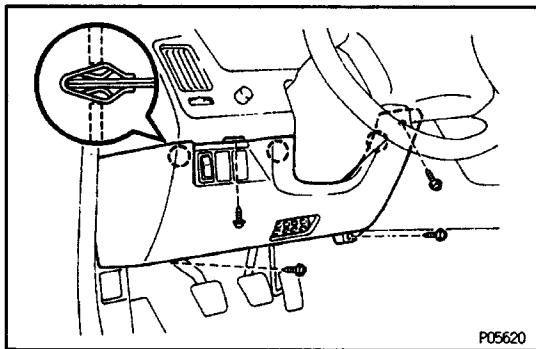

2. DISCONNECT FUEL PUMP CONNECTOR AND FUEL SENDER GAUGE CONNECTOR

- Remove the four screws, and disconnect the lower No.1 instrument panel finish panel by pulling it.
- Disconnect the connector, and remove the lower No. 1 instrument panel finish panel.
- Remove the ash receptacle box.

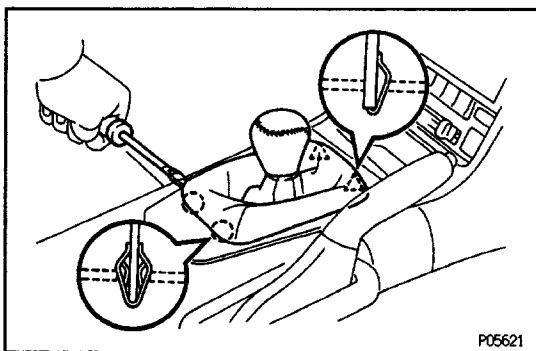

- Using a screwdriver, pry out the shifting hole cover.

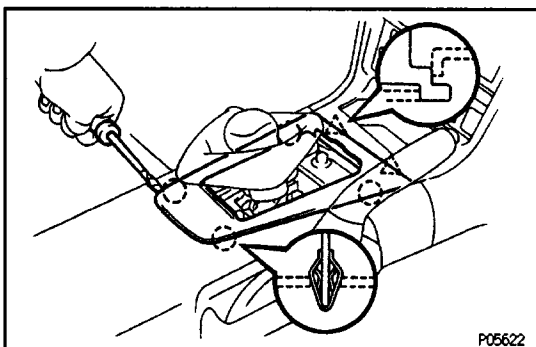

- Using a screwdriver, pry out the upper console panel.

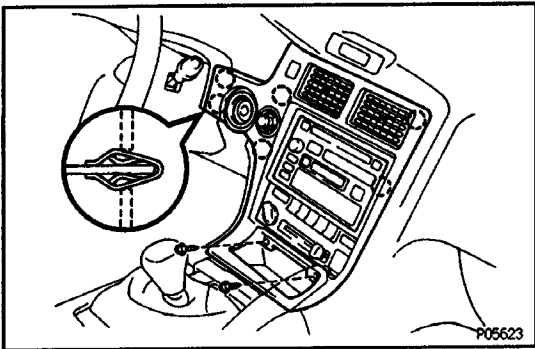

- (f) Remove the two screws, and disconnect the center instrument cluster finish panel by pulling it.
- (g) Disconnect the connectors, and remove the center instrument cluster finish panel.

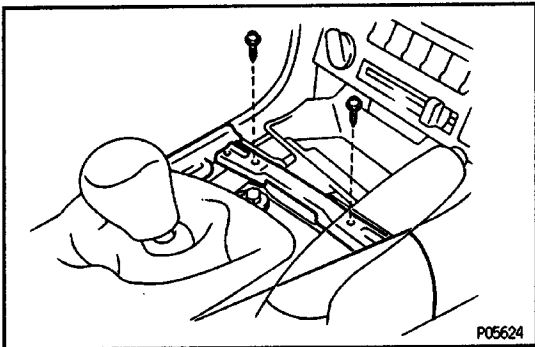

- (h) Remove the two screws holding the console box to the instrument panel safety pad.

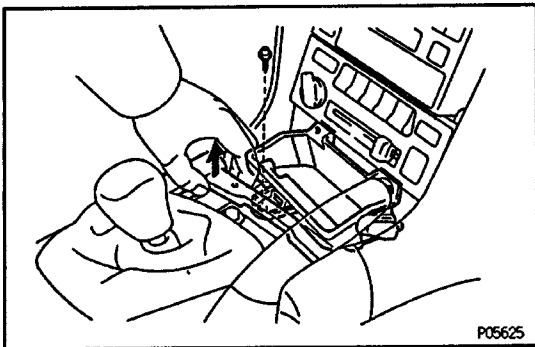

- (i) Remove the ash receptacle retainer mounting screw by lifting the front side of the console box.
- (j) Disconnect the connector, and remove the ash receptacle retainer.

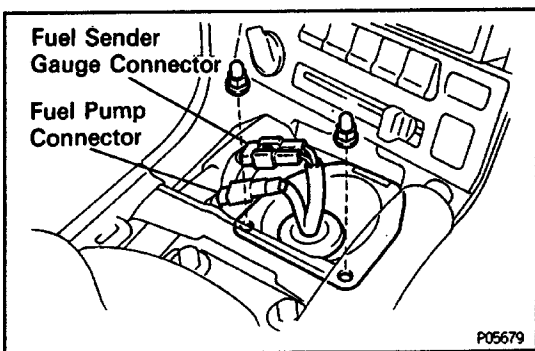

- (k) Disconnect the fuel pump connector and fuel sender gauge connector.
- (l) Remove the grommet from the service hole cover.
- (m) Remove the two nuts and service hole cover.

3. REMOVE ENGINE UNDER COVERS
4. REMOVE FRONT LUGGAGE UNDER COVER
5. REMOVE FUEL TANK PROTECTORS
6. DRAIN FUEL

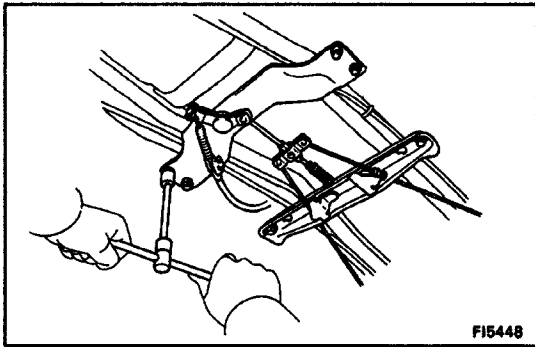

7. REMOVE PARKING BRAKE INTERMEDIATE LEVER AND NO.1 CENTER FLOOR CROSSMEMBER

- (a) Remove the four bolts and intermediate lever.
- (b) Remove the two bolts and crossmember.
- (c) Disconnect the parking brake cable from the intermediate lever.

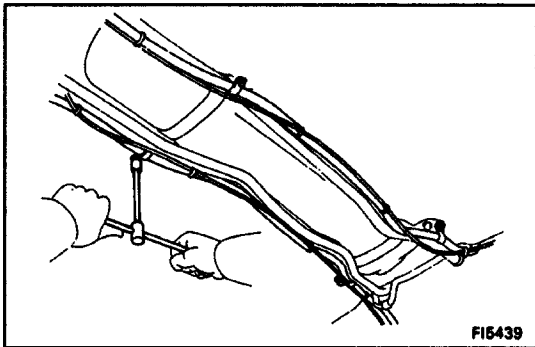

8. REMOVE A/C PIPES FROM BODY

Remove the four bolts, and disconnect the two A/C pipes from the body.

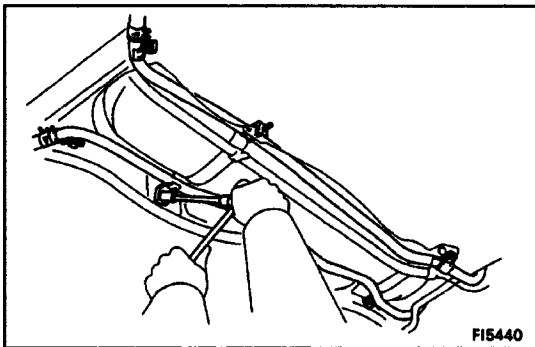

9. DISCONNECT RADIATOR PIPES FROM BODY

Remove the six bolts, and disconnect the two radiator pipes from the body.

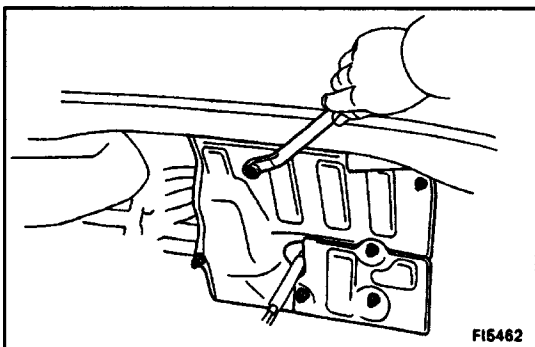

10. REMOVE FUEL TANK HEAT INSULATORS

Remove the six nuts and two heat insulators.

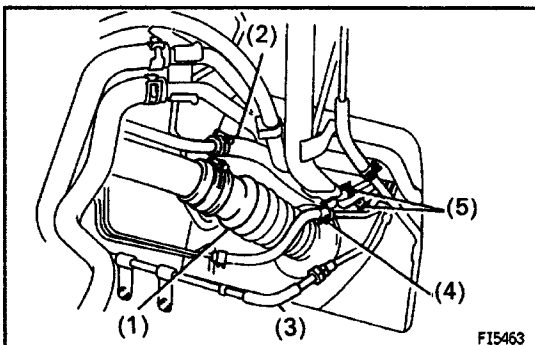

11. DISCONNECT HOSES AND TUBE

CAUTION: Remove the fuel filter cap to prevent the fuel from flowing out.

Disconnect the following hoses and tube:

- (1) Fuel inlet hose
- (2) Fuel breather hose
- (3) Fuel pump hose
- (4) Fuel return hose
- (5) Two fuel evaporative bent hose

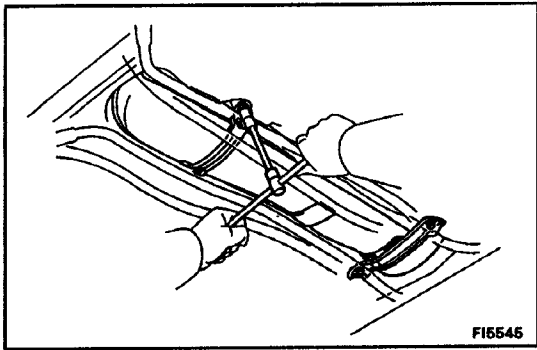

F15545

12. REMOVE FUEL TANK

- (a) Remove the bolt, pin and tank band.
- (b) Remove the two bolts and No.2 center floor cross-member.
- (c) Remove the fuel tank.

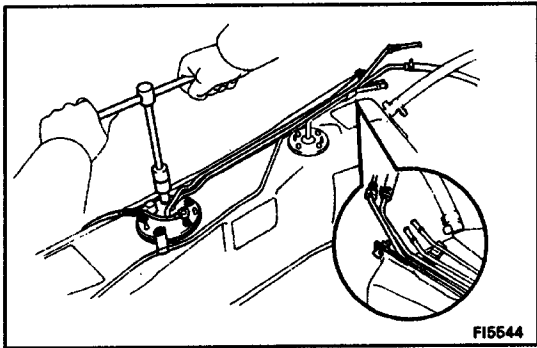

F15544

13. REMOVE FUEL PUMP ASSEMBLY FROM FUEL TANK

- (a) Remove the bolt holding the fuel pump tube to the fuel tank.
- (b) Remove the five bolts, and pull out the fuel pump assembly.
- (c) Remove the gasket from the pump bracket.

COMPONENTS FOR DISASSEMBLY AND ASSEMBLY

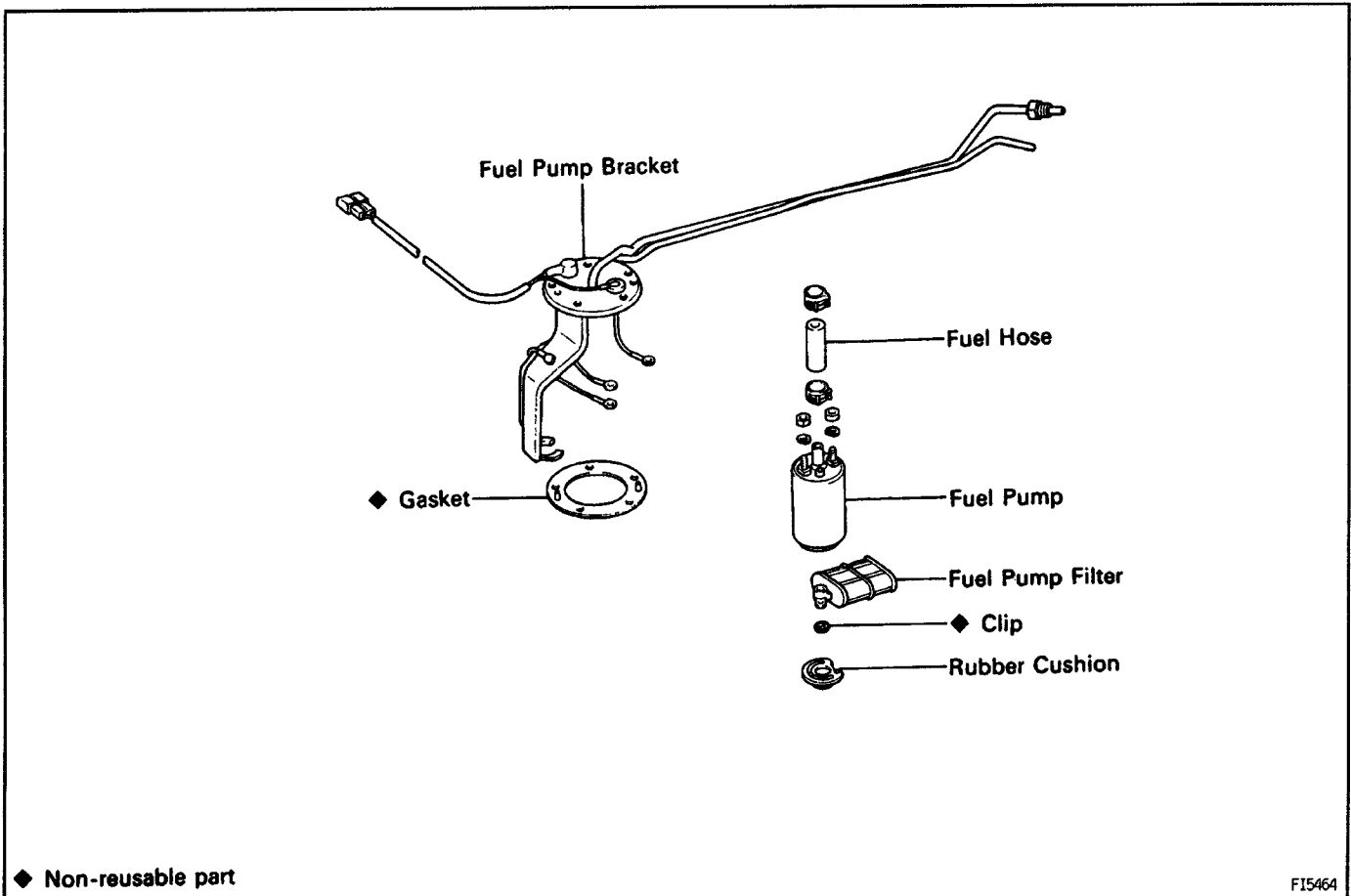

F15464

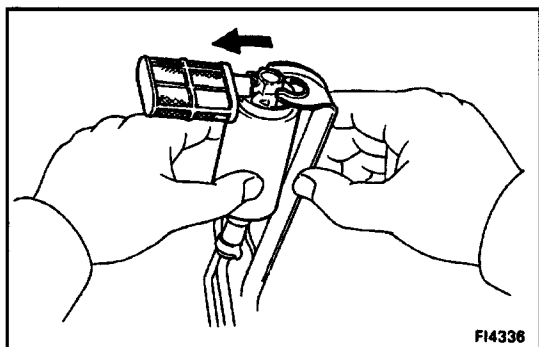

F14336

FUEL PUMP DISASSEMBLY

(See Components for Disassembly and Assembly)

1. REMOVE FUEL PUMP FROM FUEL PUMP BRACKET

- Pull out the lower side of the fuel pump from the pump bracket.
- Remove the rubber cushion from the fuel pump.
- Remove the nut and spring washer, and disconnect the lead wire from the fuel pump. Disconnect the three lead wires.
- Disconnect the fuel hose from the fuel pump, and remove the fuel pump.

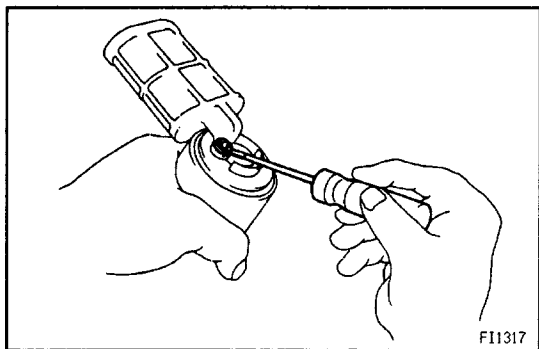

F11317

2. REMOVE FUEL PUMP FILTER FROM FUEL PUMP

- Using a small screwdriver, pry out the clip.
- Pull out the pump filter.

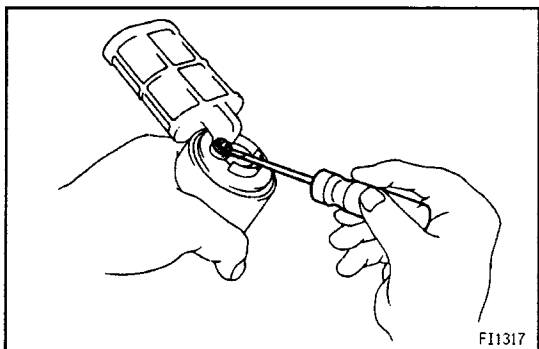

F11317

FUEL PUMP ASSEMBLY

(See Components for Disassembly and Assembly)

1. INSTALL FUEL PUMP FILTER TO FUEL PUMP

Install the pump filter with a new clip.

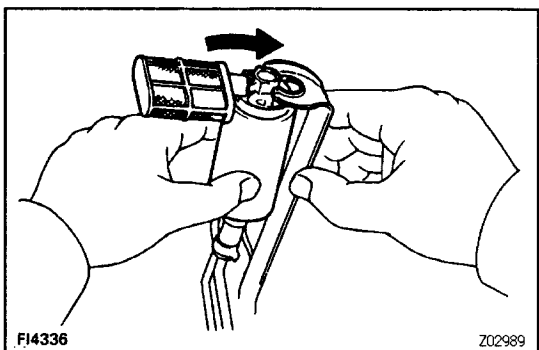

F14336

Z02989

2. INSTALL FUEL PUMP TO FUEL PUMP BRACKET

- Connect the fuel hose to the outlet port of the fuel pump.
- Connect the lead wire to the fuel pump with the spring washer and nut. Connect the three lead wires.
- Install the rubber cushion to the fuel pump.
- Install the fuel pump by pushing the lower side of the fuel pump.

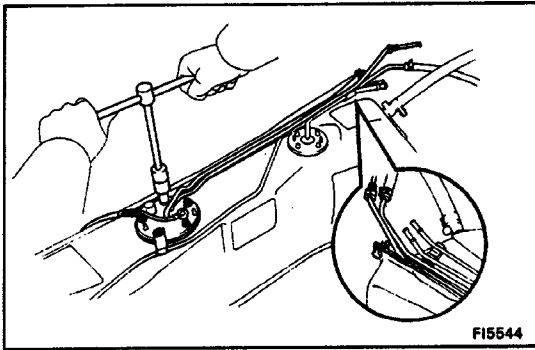

F15544

FUEL PUMP INSTALLATION

(See Components for Removal and Installation)

1. INSTALL FUEL PUMP ASSEMBLY TO FUEL TANK

- (a) Install a new gasket to the pump bracket.
- (b) Insert the fuel pump assembly into the fuel tank.
- (c) Install the five bolts holding the fuel pump bracket to the fuel tank.

Torque: 3.4 N-m (35 kgf-cm, 30in.-lbf)

- (d) Install the five bolts holding the fuel pump tube to the fuel tank.

2. INSTALL FUEL TANK

- (a) Apply soapy water to the cushions on the fuel tank.

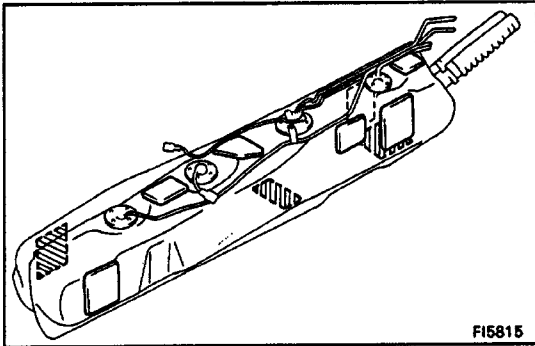

F15815

- (b) Attach the fuel tank to the body.
- (c) Install the fuel tank band with the pin and bolt.

Torque: 29 N-m (300 kgf-cm, 22 ft-lbf)

- (d) Install the No.2 center floor crossmember with the two bolts.

Torque: 29 N-m (300 kgf-cm, 22 ft-lbf)

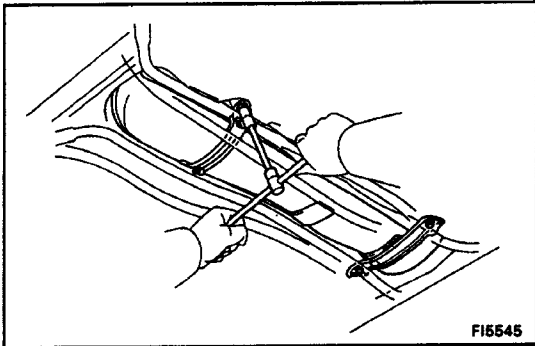

F15545

3. CONNECT HOSES AND TUBE

Connect the following hoses and tube:

- (1) Fuel inlet hose
- (2) Fuel breather hose
- (3) Fuel pump hose
- (4) Fuel return hose
- (5) Two fuel evaporative bent hose

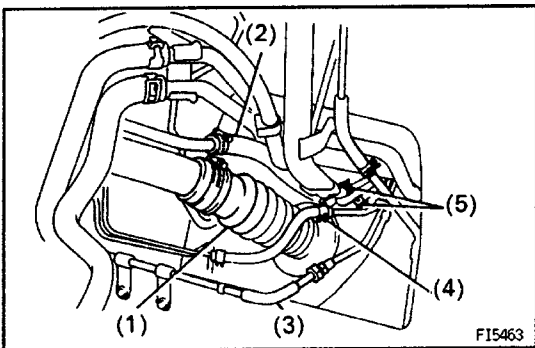

F15463

4. INSTALL RADIATOR PIPES TO BODY

Install the two radiator pipes with the six bolts.

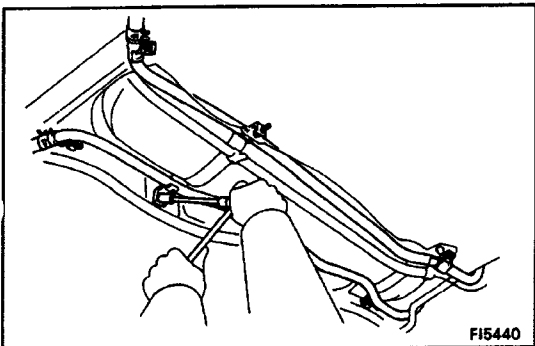

F15440

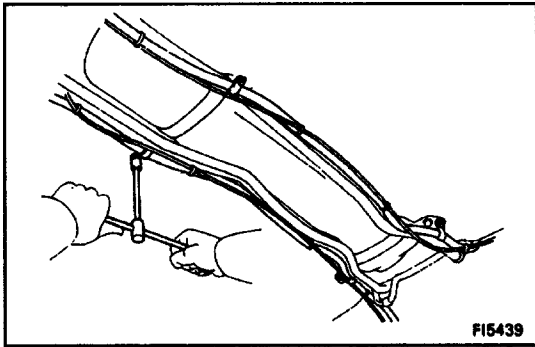

5. INSTALL A/C PIPES TO BODY

Install the two A/C pipes with the four bolts

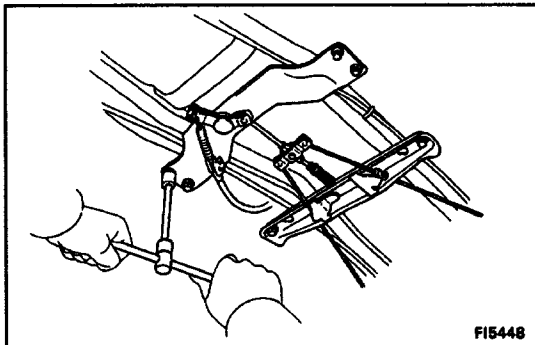

6. INSTALL PARKING BRAKE INTERMEDIATE LEVER AND NO.1 CENTER FLOOR CROSSMEMBER

- (a) Connect the parking brake cable to the intermediate lever.
- (b) Install the intermediate lever with the four bolts.
- (c) Install the crossmember with the two bolts.

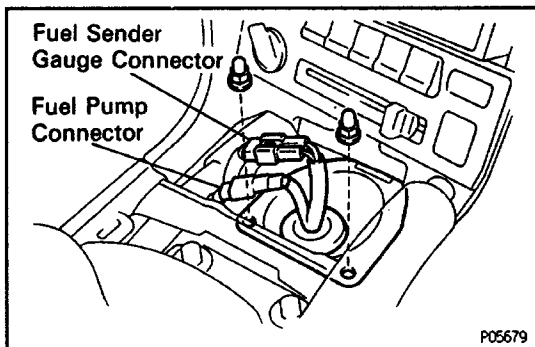

7. CONNECT FUEL PUMP CONNECTOR AND FUEL SENDER GAUGE CONNECTOR

- (a) Install the service hole cover with the two nuts.
- (b) Connect the fuel pump connector and fuel sender gauge connector.
- (c) Install the grommet to the service hole cover.

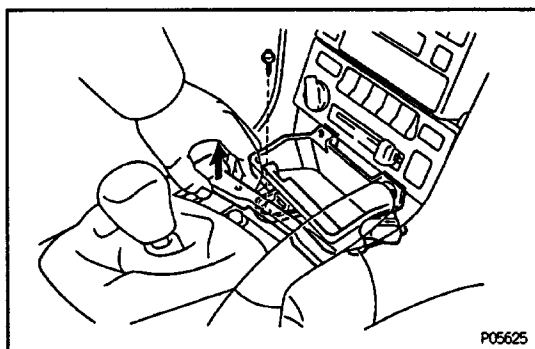

- (d) Connect the connector, and install the ash receptacle retainer with the screw by lifting the front side of the console box.

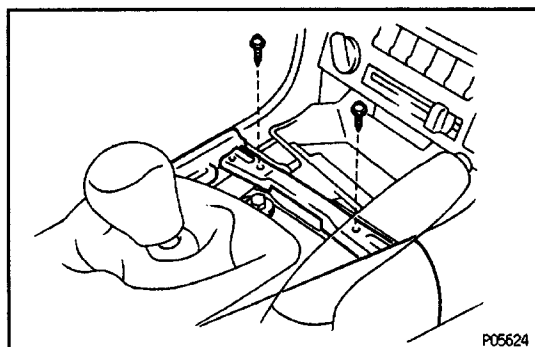

- (e) Install the console box to the instrument panel safety pad with the two screws.

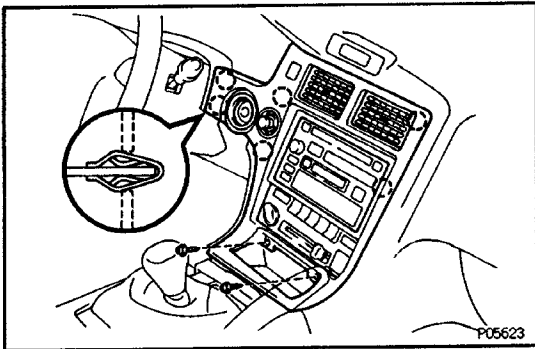

- (f) Connect the connectors, and attach the center instrument cluster finish panel to the instrument panel safety pad with the clips.
- (g) Install the two screws.

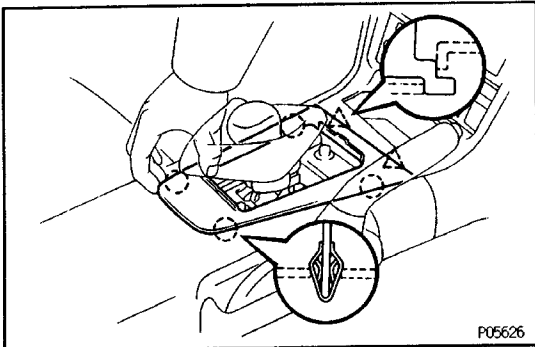

- (h) Connect the connector, and attach the upper console panel to the console panel with the two claws and two clips.

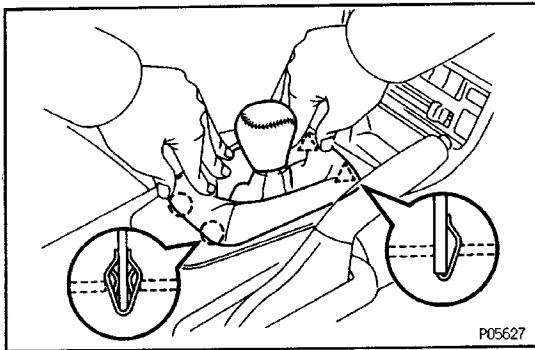

- (i) Attach the shifting hole cover with the four clips.
- (j) Install the ash receptacle box.

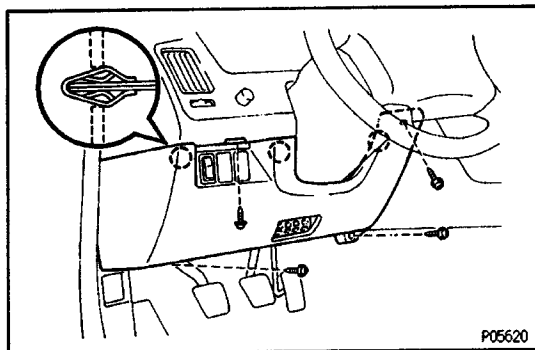

- (k) Connect the connector, and attach the lower No.1 instrument panel finish panel with the three clips.
- (l) Install the four screws.

8. FILL WITH FUEL

9. CONNECT CABLE TO NEGATIVE TERMINAL OF BATTERY

10. CHECK FOR FUEL LEAKS

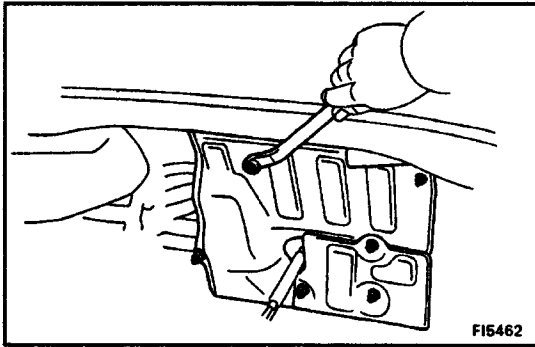
**11. INSTALL FUEL TANK HEAT INSULATORS**

Install the two heat insulators with the six nuts.

12. INSTALL FUEL TANK PROTECTORS**13. INSTALL FRONT LUGGAGE UNDER COVER****14. INSTALL ENGINE UNDER COVERS**