

VSV (For EGR)

FIG. 2-04

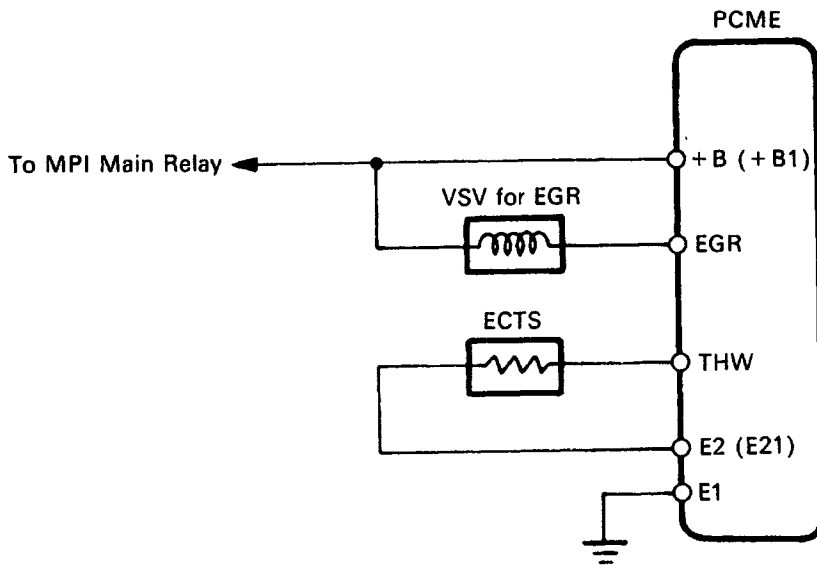
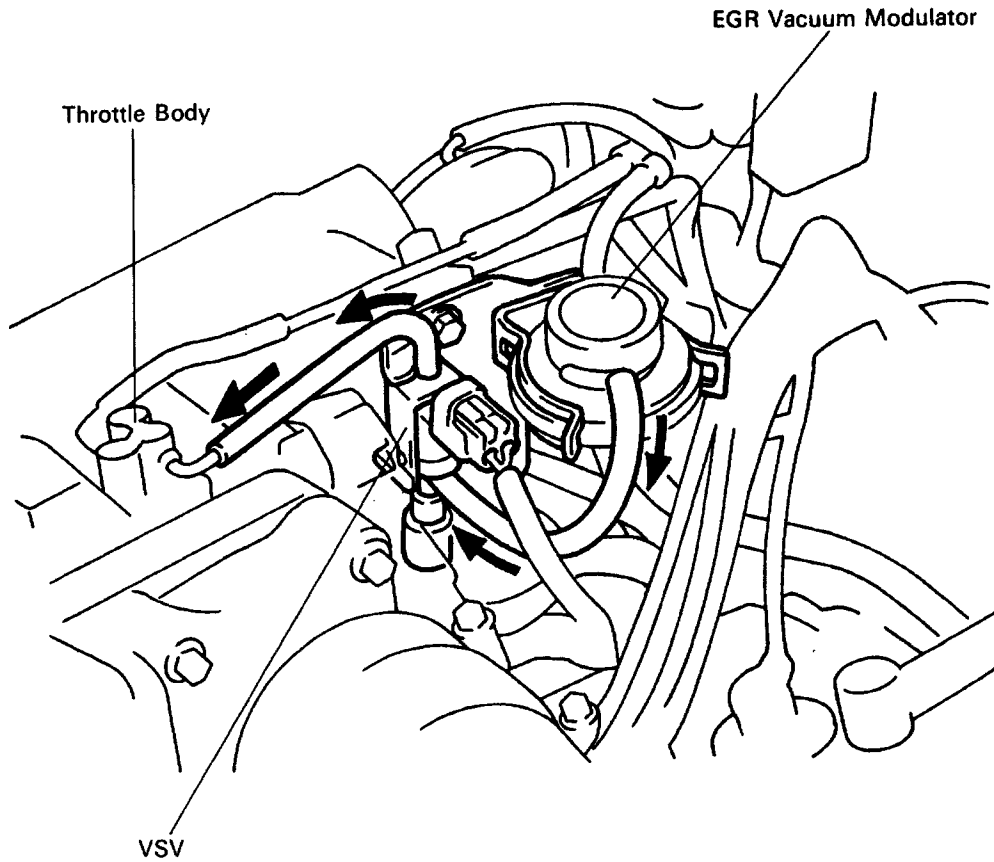

COMPONENTS FOR REMOVAL AND INSTALLATION

E0022-01

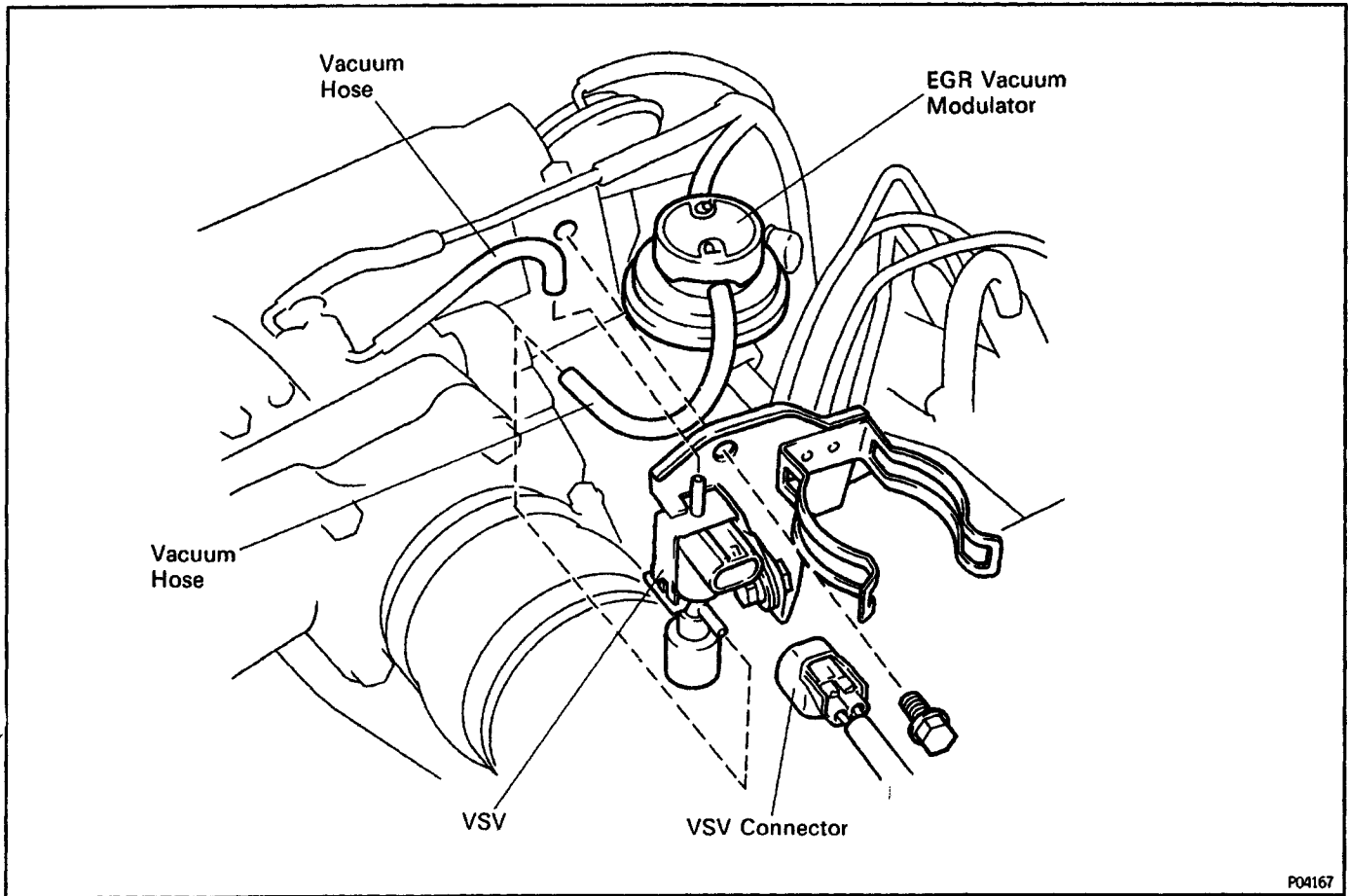

P04167

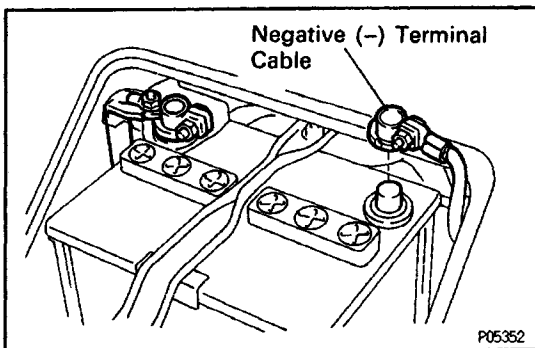

P05352

VSV INSPECTION

E0022-01

(See Components for Removal and Installation)

1. DISCONNECT CABLE FROM NEGATIVE TERMINAL OF BATTERY

CAUTION: Turn the ignition switch to 'LOCK'. Disconnect the negative terminal from the battery. Wait at least 20 seconds before proceeding with work.

2. REMOVE VSV

(a) Disconnect the following connector and hoses:

- (1) VSV connector
- (2) Vacuum hose (from EGR vacuum modulator) from port E of VSV
- (3) Vacuum hose (from throttle body) from port G of VSV

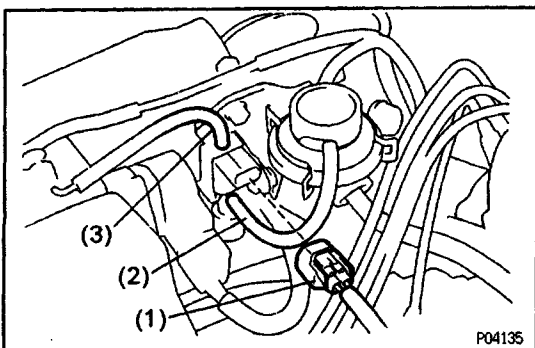

P04135

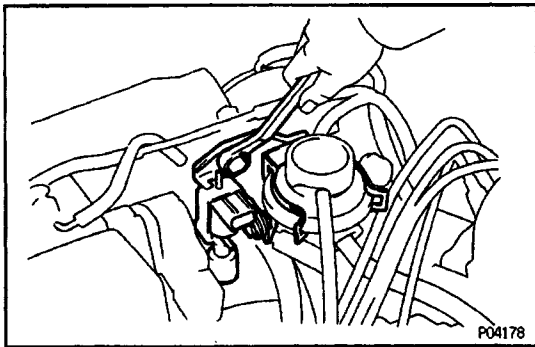

(b) Remove the bolt, and disconnect the VSV from the intake manifold.

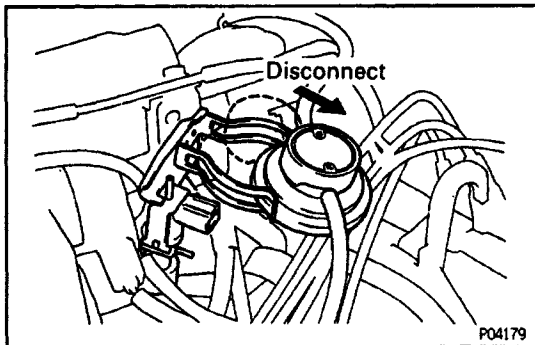

(c) Disconnect the clamp from the EGR vacuum modulator, and remove the VSV.

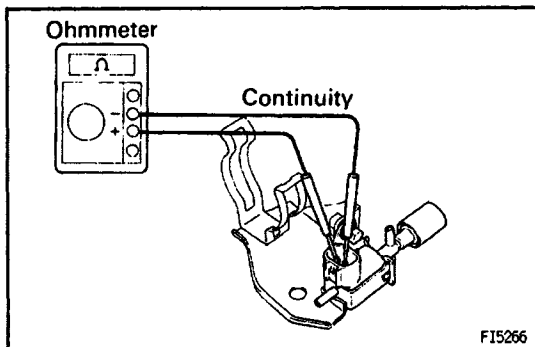

3. INSPECT VSV

A. Inspect VSV for open circuit

Using an ohmmeter, check that there is continuity between the terminals.

Resistance (Cold):

33-39Ω

If there is no continuity, replace the VSV.

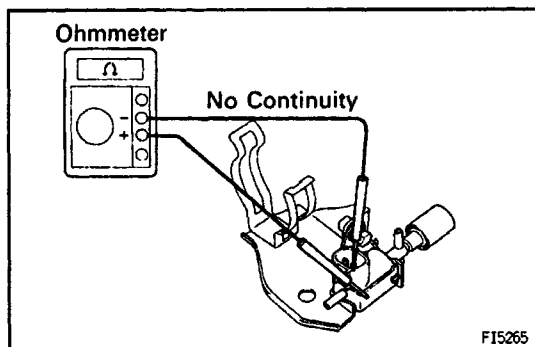

B. Inspect VSV for ground

Using an ohmmeter, check that there is no continuity between each terminal and the body.

If there is continuity, replace the VSV.

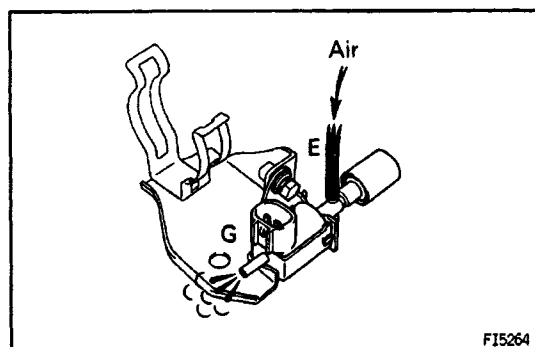

C. Inspect VSV operation

(a) Check that the air flows from port E to port G.

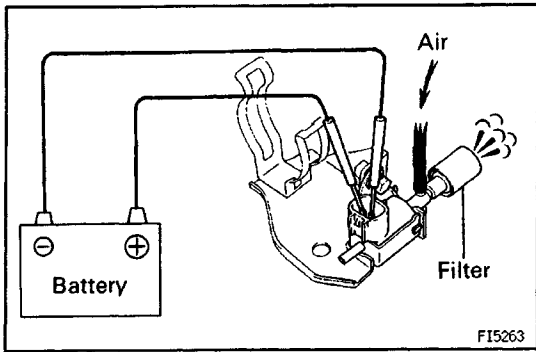

- (b) Apply battery voltage across the terminals.
 (c) Check that the air flows from port E to the filter.
 If operation is not as specified, replace the VSV.

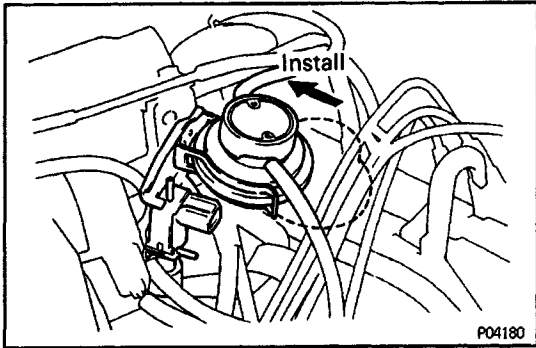

4. REINSTALL VSV

- (a) Connect the EGR vacuum modulator to the EGR vacuum modulator.

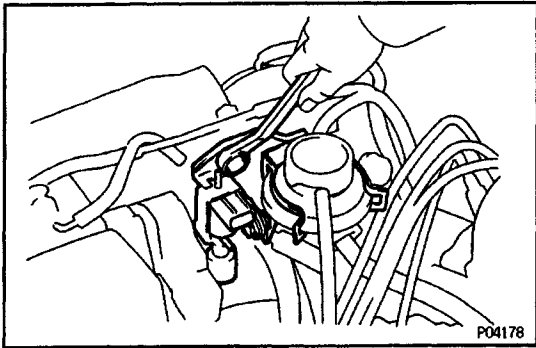

- (b) Install the VSV with the bolt and screw.

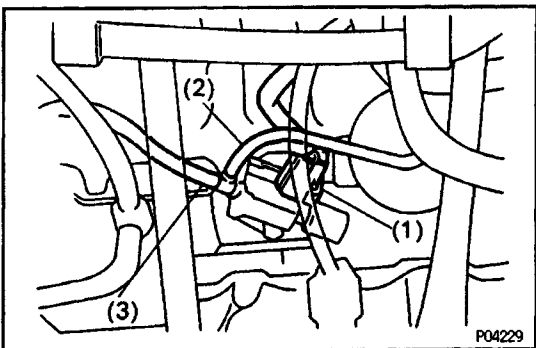

- (c) Connect the following connector and hoses:
 (1) VSV connector
 (2) Vacuum hose (from EGR vacuum modulator) to port E of VSV
 (3) Vacuum hose (from throttle body) to port G of VSV

5. RECONNECT CABLE TO NEGATIVE TERMINAL OF BATTERY