

OIL PUMP COMPONENTS

MX01E-01

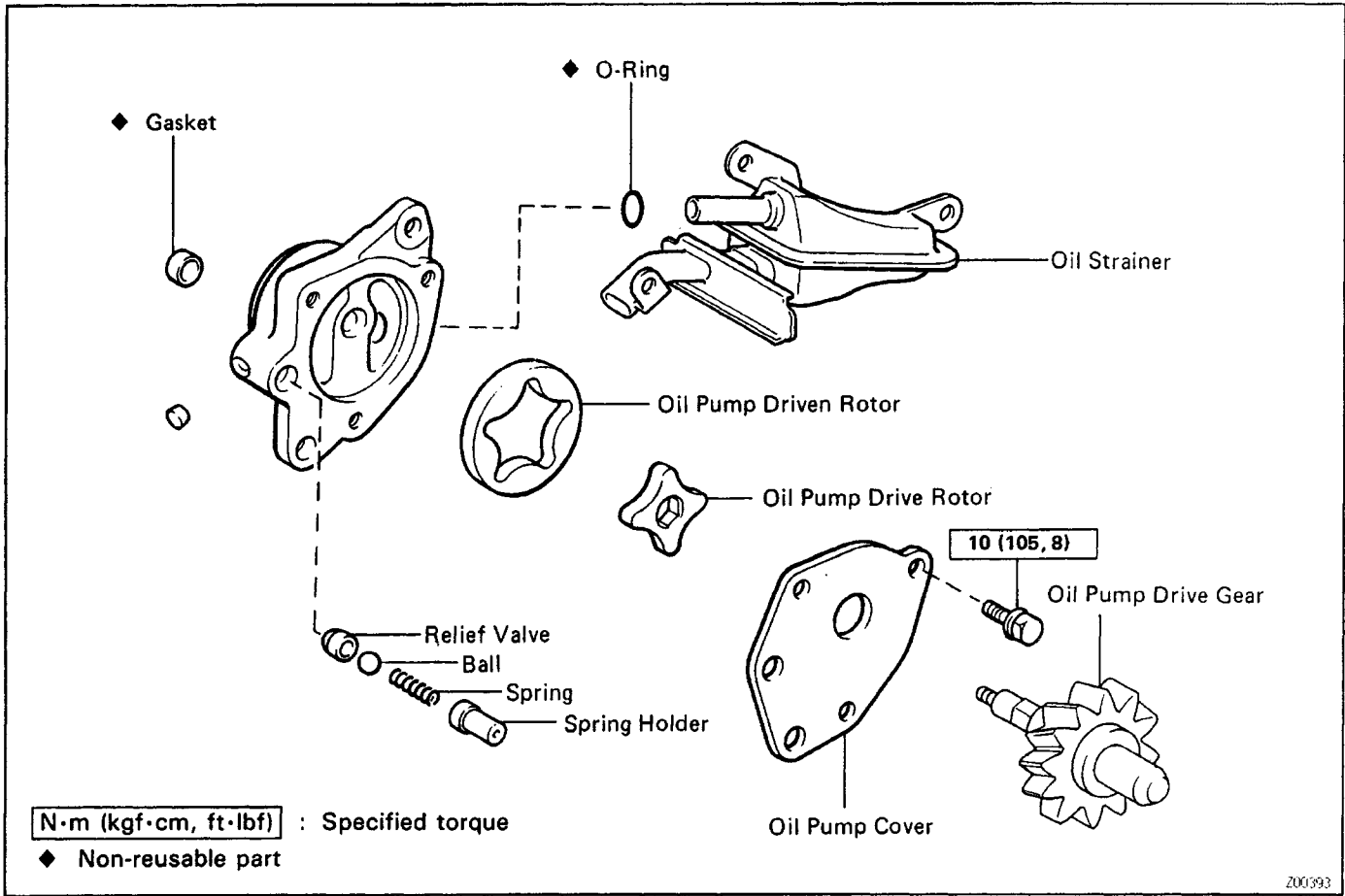

MX01F-01

OIL PUMP DISASSEMBLY

1. CHECK OPERATION OF OIL PUMP

Install the oil pump drive gear to the drive rotor, check that the drive rotor turns smoothly.

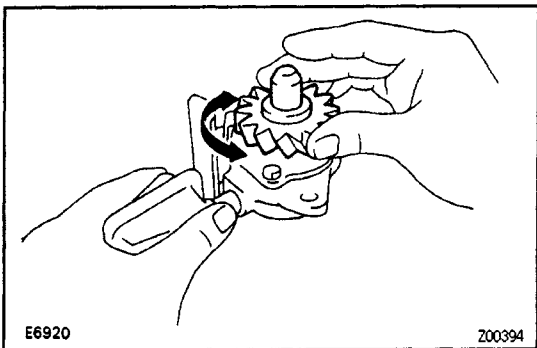

2. REMOVE GASKET FROM OIL PUMP CASE

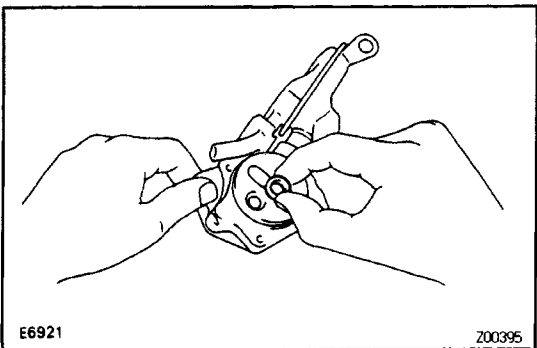

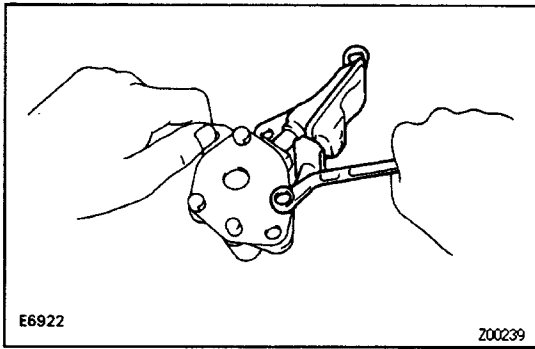

3. REMOVE BOLT AND OIL STRAINER

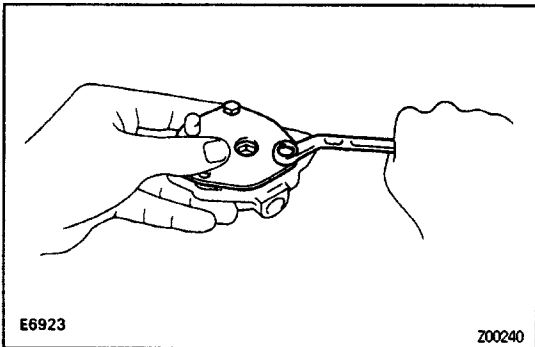

4. REMOVE OIL PUMP COVER

- (a) Hold the pump cover, remove the two bolts and a cover.

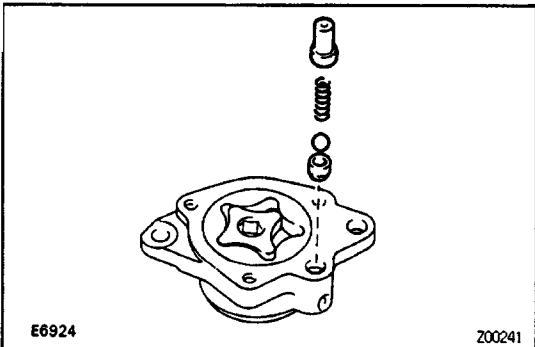

- (b) Remove the spring holder, spring, ball and relief valve seat.

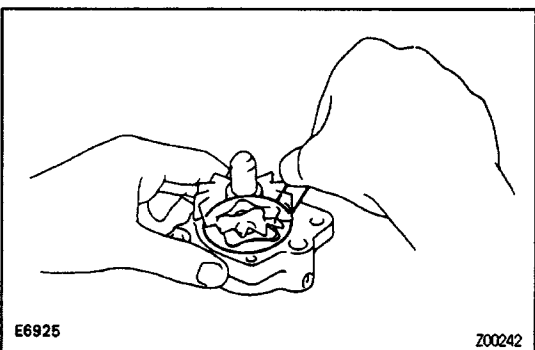

5. CHECK ROTOR BODY CLEARANCE

- (a) Install the oil pump drive gear to the drive rotor.
 (b) Using a feeler gauge, measure the body clearance between the drive rotor and oil pump case.

Standard clearance:

0.10–0.16 mm (0.0039–0.0063 in.)

Maximum clearance:

0.30 mm (0.0118 in.)

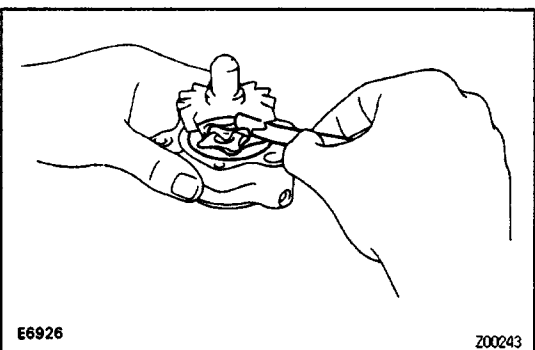

6. CHECK ROTOR TIP CLEARANCE

- (a) Install the oil pump drive gear to the drive rotor.
 (b) Using a feeler gauge, measure the tip clearance between the drive and driven rotors.

Standard clearance:

0.08–0.15 mm (0.0031–0.0058 in.)

Maximum clearance:

0.30 mm (0.0118 in.)

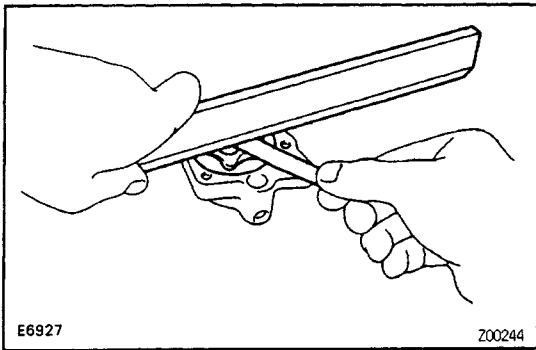

7. CHECK SIDE CLEARANCE

Using a precision straight edge and feeler gauge, measure the side clearance of both rotors.

Standard clearance:

0.03–0.08 mm (0.0012–0.0031 in.)

Maximum clearance:

0.15 mm (0.0059 in.)

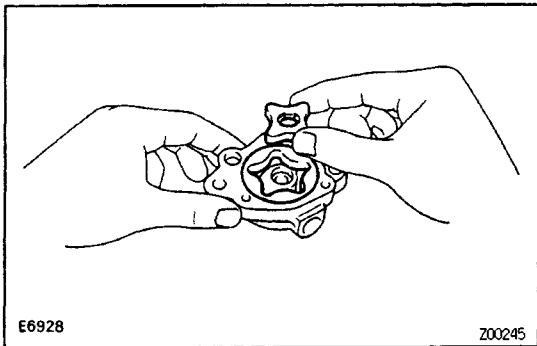

8. REMOVE OIL PUMP DRIVE ROTOR AND DRIVEN ROTOR

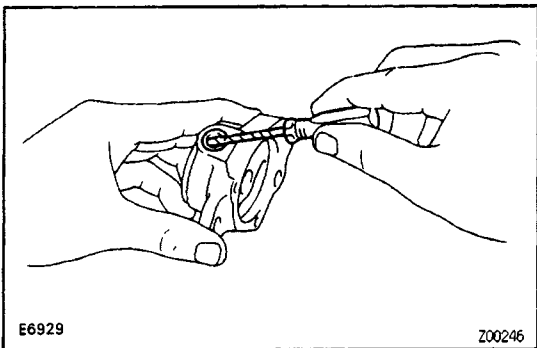

9. IF NECESSARY, REPLACE O-RING

(a) Using a screwdriver, remove the O-ring.

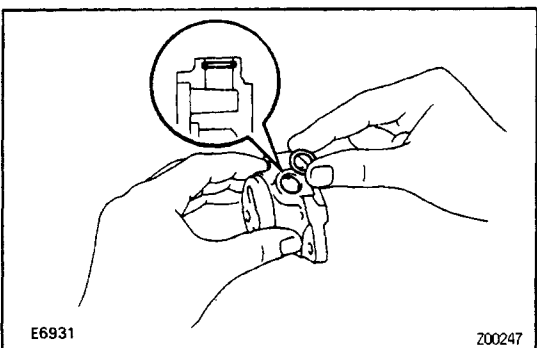

(b) Apply gear oil to the O-ring.

(c) Install the O-ring.

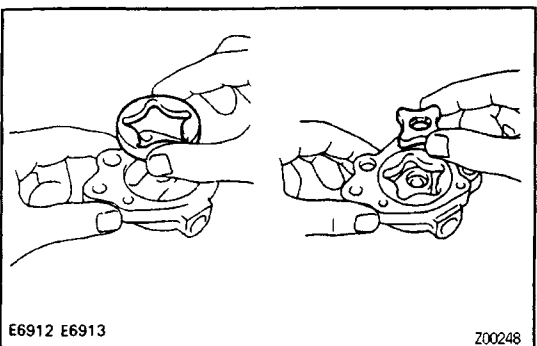

OIL PUMP ASSEMBLY

(See page [MX2-51](#))

1. INSTALL DRIVEN ROTOR AND DRIVE ROTOR

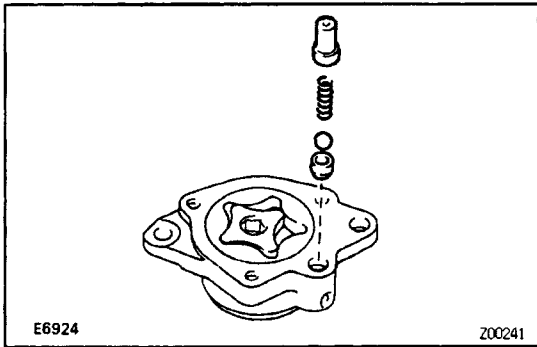

2. INSTALL OIL PUMP COVER

(a) Install the relief valve, ball, spring and spring holder to the oil pump case.

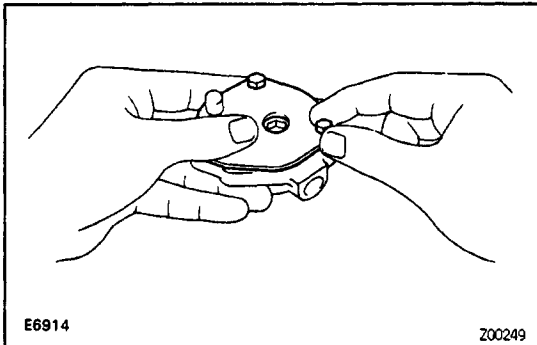

(b) Hold the oil pump cover, temporarily install the two bolts.

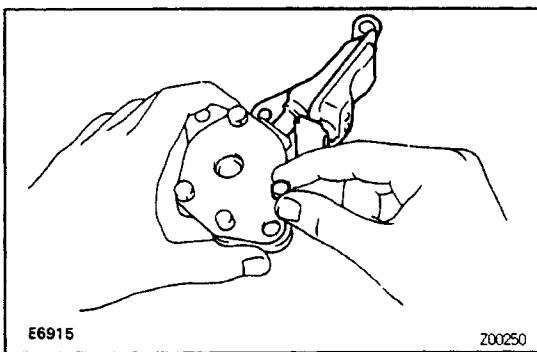

3. INSTALL OIL STRAINER

Install the oil strainer to the oil pump case, temporarily install the bolt.

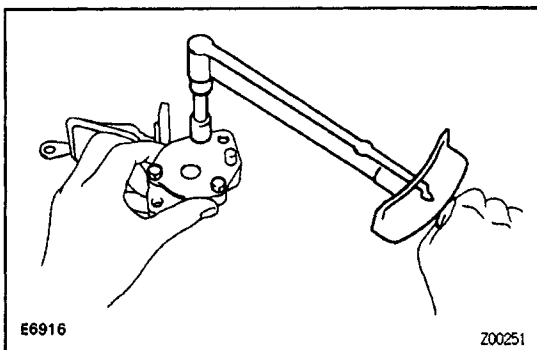

4. TORQUE OIL PUMP COVER BOLTS

Torque the three bolts evenly.

Torque: 10 N-m (105 kgf-cm, 8 ft-lbf)

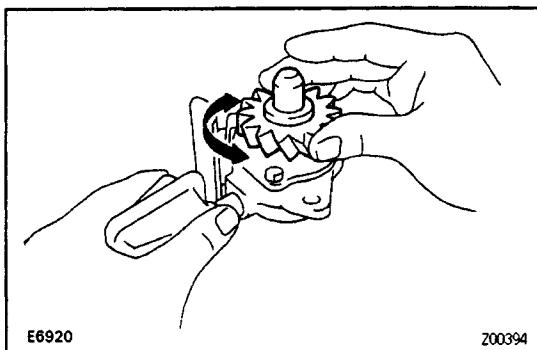

5. CHECK OPERATION OF OIL PUMP

Install the oil pump drive gear to the drive rotor, check that the drive rotor turns smoothly.

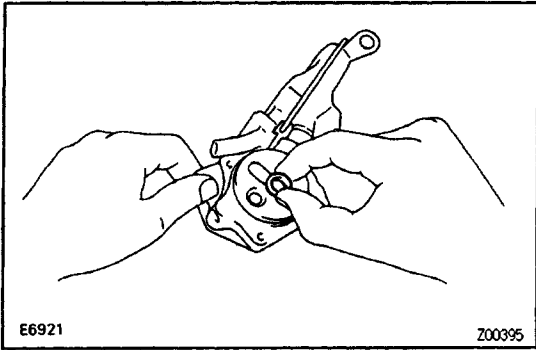

6. INSTALL GASKET

Install a new gasket to the oil pump case.