

DIAGNOSIS SYSTEM DESCRIPTION

BR076-01

If a malfunction occurs, the system will identify the problem and the ECU will store the codes for the trouble items.

At the same time, the system informs the driver of a malfunction via the "ABS" warning light in the combination meter.

To identify the trouble by the number of blinks (diagnostic code) of the warning light turn on the ignition switch, disconnect the service connector, and use SST to connect Tc and E1 of the data link connector.

In the event of two codes, that having the smallest number (code) will be identified first.

HINT: The warning light does not show the diagnostic codes while the vehicle is running.

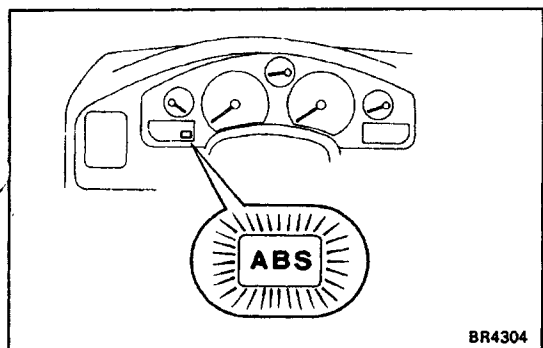
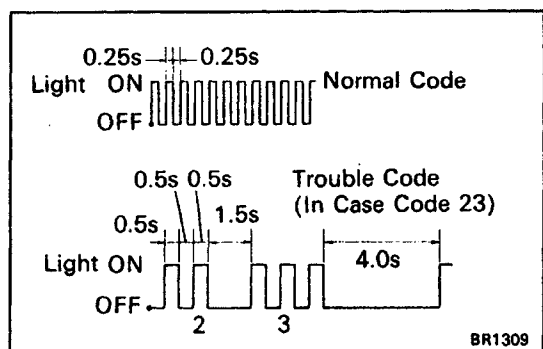

DIAGNOSIS SYSTEM INSPECTION

BR077-01

1. INSPECT BATTERY VOLTAGE

Inspect that the battery voltage is about 12 V.

2. CHECK THAT WARNING LIGHT TURNS ON

- (a) Turn the ignition switch on.
- (b) Check that the "ABS" warning light turns on for 3 seconds.

If not, inspect and repair or replace the fuse, bulb and wire harness.

3. REAR DIAGNOSTIC CODE

- (a) Turn the ignition switch on.
- (b) Disconnect the service connector.

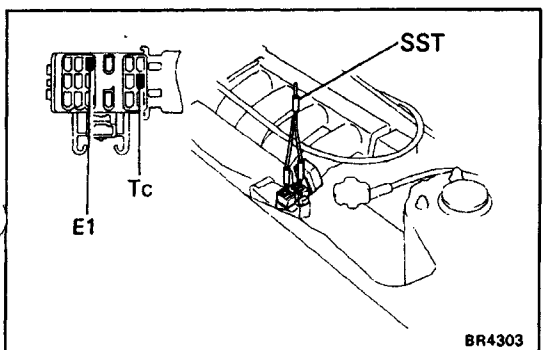
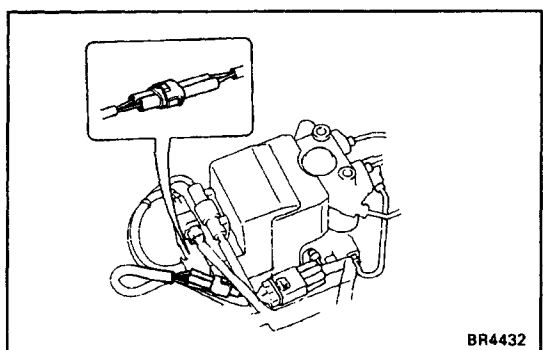

- (c) Using SST, connect terminals Tc and E1 of the data link connector.

SST 09843-18020

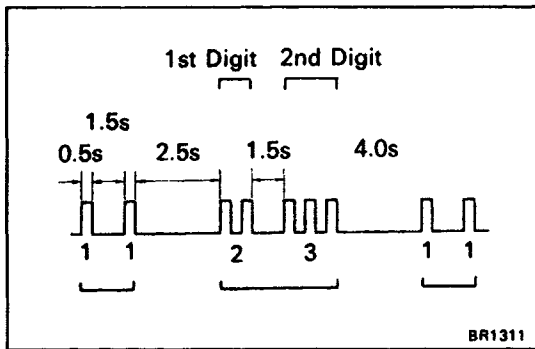

(d) In event of a malfunction, 4 seconds later the warning light will begin to blink. Read the number of blinks.

(See DIAGNOSTIC CODE on page BR-55)

HINT: The first number of blinks will equal the first digit of a two digit diagnostic code. After a 1.5 second pause, the 2nd number of blinks will equal the 2nd number of a two digit code. If there are two or more codes, there will be a 2.5 second pause between each, and indication will begin after 4.0 second pause from the smaller value and continue in order to larger.

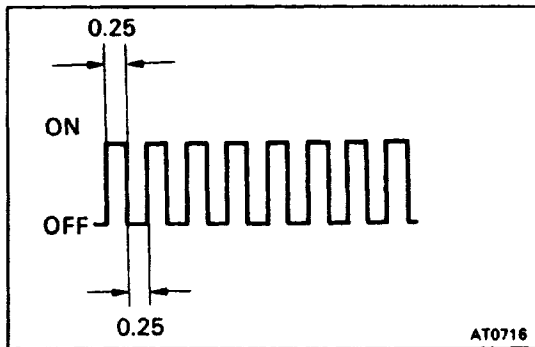

(e) If the system is operating normally (no malfunction), the warning light will blink once every 0.5 seconds.

(f) Repair the system.

(g) After the malfunctioning components has been repaired, clear the diagnostic codes stored in the ECU.

(See page BR-55)

HINT: If you disconnect the battery cable while repairing, all diagnostic codes in the ECU will erased.

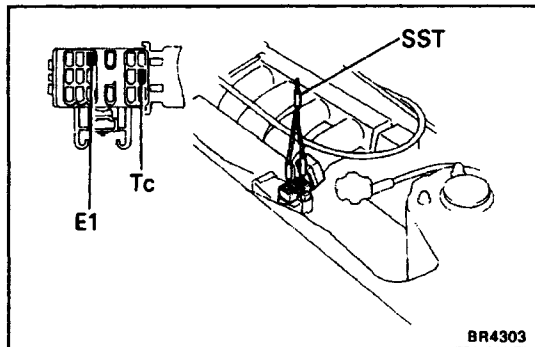











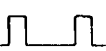

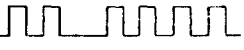

(h) Remove the SST from terminals Te and E1 of the data link connector.

SST 09843-18020

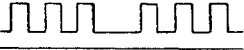
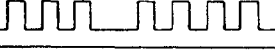
(i) Connector the service connector.

(j) Turn the ignition switch on, and check that the "ABS" warning light goes off after the warning light goes on for 3 seconds.

DIAGNOSTIC CODE

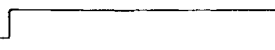
Code No.	Light Pattern	Diagnosis	Trouble Part
11	ON OFF 	Open circuit in solenoid relay circuit	<ul style="list-style-type: none"> • Actuator inside wire harness • Control relay
12		Short circuit in solenoid relay circuit	<ul style="list-style-type: none"> • Wire harness and connector of solenoid relay circuit
13		Open circuit in pump motor relay circuit	<ul style="list-style-type: none"> • Actuator inside wire harness • Control relay
14		Short circuit in pump motor relay circuit	<ul style="list-style-type: none"> • Wire harness and connector of pump motor relay circuit
21		Open or short circuit in 3 position solenoid of front right wheel	<ul style="list-style-type: none"> • Actuator solenoid • Wire harness and connector of actuator solenoid circuit
22		Open or short circuit in 3 position solenoid of front left wheel	
23		Open or short circuit in 3 position solenoid of rear right wheel	
24		Open or short circuit 3 position solenoid of rear left wheel	
31		Front right wheel speed sensor signal malfunction	<ul style="list-style-type: none"> • Speed sensor • Sensor rotor • Wire harness and connector of speed sensor
32		Front left wheel speed sensor signal malfunction	
33		Rear right wheel speed sensor signal malfunction	
34		Rear left wheel speed sensor signal malfunction	
35		Open circuit in front left or rear right wheel speed sensor	
36		Open circuit in front right or rear left wheel speed sensor	
37		Wrong both rear axle hubs	<ul style="list-style-type: none"> • Rear sensor rotors
41		Abnormal battery voltage (less than 9.5 V/more than 16.2 V)	<ul style="list-style-type: none"> • Battery • Voltage regulator
51		Pump motor of actuator locked or open circuit in pump motor circuit in actuator	<ul style="list-style-type: none"> • Pump motor, relay and battery • Wire harness, connector and ground bolt or actuator pump motor circuit
Always on		Malfunction in ECU	<ul style="list-style-type: none"> • ECU

DIAGNOSTIC CODES CLEARING

CLEAR DIAGNOSTIC CODES

- (a) Turn the ignition switch on.
- (b) Using SST, connect terminals Tc and E1 of the data link connector.
SST 09843-18020

HINT: Keep the vehicle stopped vehicle speed 0 km/h (0 mph).

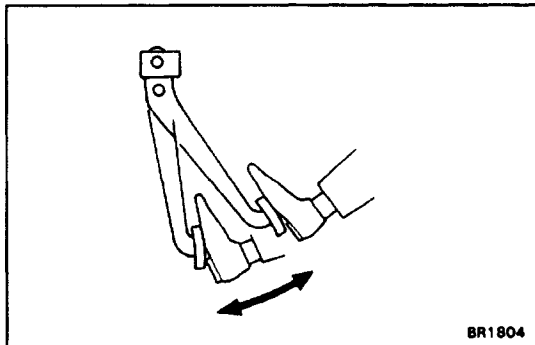
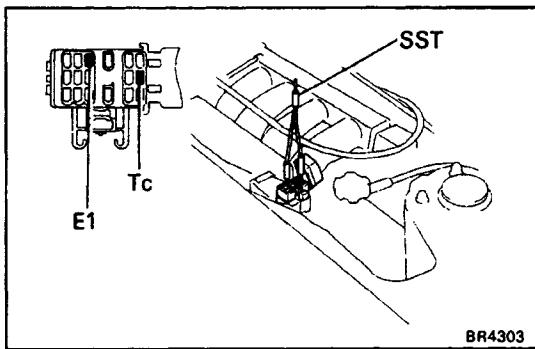

- (c) Clear the diagnostic codes stored in ECU by depressing the brake pedal 8 or more times within 3 seconds.

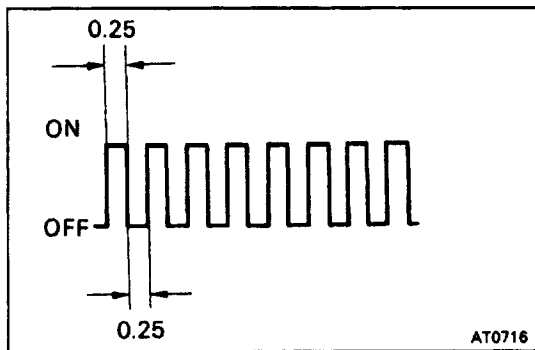

- (d) Check that the warning light shows the normal code.

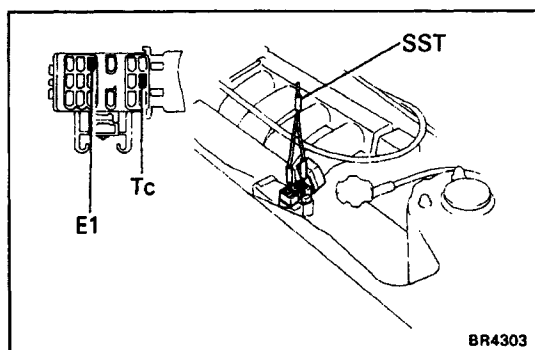

- (e) Remove the SST from terminals Tc and E1 of the data link connector.
SST 09843-18020

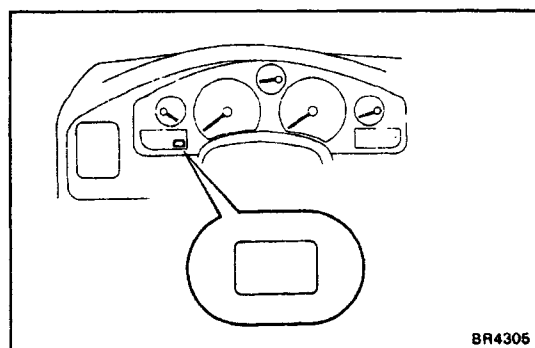

- (f) Check that the warning light goes off.